

Intelligent Addressable Control Panel

CF3000 Installation and Operation Manual

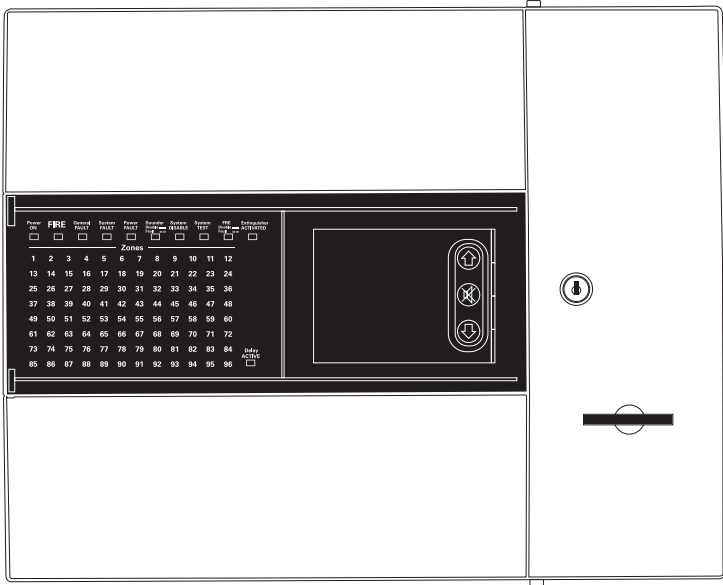

EATON

Powering Business Worldwide

Contents

Contents

INTRODUCTION	11
Project planning.....	11
SYSTEM DESIGN GUIDELINES	12
Guidelines	12
Loop lengths	12
Loop loading - total number of addresses.....	12
Repeater Panels	12
Loop Loading System Verification	13
COMPATIBLE EQUIPMENT	13
Compatible callpoints	19
Compatible sounders and beacons	19
Base sounder.....	20
Base sounder beacon	20
Visual Alarm Devices (VADs).....	21
Loop powered beacon.....	21
Dedicated stand alone sounders.....	22
Interfaces.....	23
3 channel I/O devices	23
1 channel I/O device with mains rated switching	24
Zone monitor units	25
4 way sounder circuit controller	27
4-20mA interfaces	27
Micro interfaces.....	28
Technical input/output unit.....	29
Fan controller interfaces	30
EQUIPMENT COMPATIBILITY	31
Sensors	31
Call points	31
Sounders	31
Relay circuits	31
Relays/auto-dialers and auxiliary equipment	32
Additional instructions for electromagnetic compatibility	32

SYSTEM OVERVIEW	33
Simple user interface	33
User configuration and maintenance facilities	33
Sophisticated sounder control facilities.....	33
Spur tolerant soft addressing	34
Simple future expansion	34
Integral power supply and battery.....	35
Optional printer	35
Hinged lockable cover	35
TECHNICAL SPECIFICATION	36
Power supply (Approved EN54 pt 4)	36
Batteries	36
Inputs.....	37
Outputs	37
Fault routing equipment	37
Auxiliary relays.....	38
Printer (Optional)	38
Mechanical specification	39
Anti-tamper cover (Optional)	39
Optional functions as per EN54 P2&4	40
Panel outputs.....	40
Output fire alarm routing equipment.....	40
Output to fire alarm protecting equipment	40
Output to fault warning routing equipment	41
Delays to outputs	41
Coincidence detection.....	41
Alarm counter	41
Optional auxiliary board VDS requirement.....	42
Optional functions as per EN54 P2&4	42
Optional Functions not approved to EN54 P2&4.....	44
CABLE & WIRING	46

Contents

INSTALLATION	48
Installation guide	48
Fixing details	49
Mounting the backbox	49
Installing Cabling	49
External connections (Mains supply)	50
Networking	51
Input/outputs	52
Panel inputs	52
Panel outputs	52
Output fire alarm routing equipment	53
Output to fault warning routing equipment	53
Auxiliary relay	53
Auxiliary DC output	53
MAINTENANCE	54
Daily inspection	54
Weekly test	54
Quarterly	54
Annual test	54
Every 2-3 years	54
Every 5 years	54
Servicing	55
PANEL ASSEMBLY INFORMATION	56
Attaching the door	56
Installing a hinged cover	57
Fitting printer paper roll	58
COMMISSIONING THE CONTROL PANEL SYSTEM	59
Commissioning mode	59
Configuration	59
DB level check	59
Sensor LED flashing	59
Up/downloading using PC software	60
Panel fault finding	61
PC COMMISSIONING SOFTWARE	62

Device input programming	62
Non-Latching	63
Day / Night.	63
Cascading Delay	63
Allocate Zones/Devices	63
Sounder Trigger	64
Delay Configuration	64
MCP Override	64
Allocation List	64
Dependency detection	65
PANEL CONTROLS & INDICATORS	66
Touch screen display	68
Panel operation	69
Public access level 1	70
Evacuate (Access level 2)	71
Silence alarms	71
Mute buzzer.	72
Reset	72
Pre-alarms	73
Faults	73
Disabled devices	74
Enable/disable (Others menu)	74
Print	76
Lamp test	76
Weekly test	77
Viewing events	78
Check auto config	79
Replace device	80
Test Device (Access Level 3)	81
Test zone	82
Sounder level test mode	82
Global flashing LED On/Off	83
One man walk test	84
Commission.	85

Contents

Load CDR from laptop85
Download CDR from laptop86
Auto learn87
Erase log88
System details89
Analogue level90
Printer settings91
Change panel number92
Number of panels in network93
Screen cover94
Programming I/O and sounders95
Sound settings96
Change date/time97
Change text98
Change zone text99
Change panel text	100
Configure zones	101
Change user code	102
Add zone	103
Delete zone	104
Add device	105
Delete device	106
Configure heat detectors	107
Network	108
Password protection	108

APPENDIX 109

System wiring	109
Detector base wiring (CAB300)	110
Call point wiring (CBG370S/CBG370WP)	111
Base sounder wiring (CAS380, CASBB384)	111
Loop powered beacon wiring (CAB382)	112
Wall sounder wiring (CAS381, CASB383)	112
IP66 wall sounder wiring (CAS381WP, CASB383-WP)	113
Base Sounder VAD (CASBB394)	114

Contents

Wall Sounder VAD (CASB393)	115
IP66 Wall Sounder VAD (CASB393WP)	116
3 way input output unit (CIO351, CIO351S, CIO351SST)	117
1 Channel mains rated I/O unit wiring (CMIO353)	118
Zone monitor unit wiring (CZMU352)	119
Intrinsically safe zone monitor unit wiring (CZMU352-IS)	120
Shop monitor unit wiring (MSU840)	121
Spur isolator wiring (CSI350)	122
4 Way sounder controller wiring (CSC354CPR)	123
4-20mA interface wiring (CGI420, CIT420, CGI420R, CIT420R)	124
Micro zone monitor module wiring (CIU872)	125
Micro input module wiring (MCIM)	126
Micro output module wiring (MCOM, MCOM-R, MCOM-S, MCOM-FC)	127
Typical smoke management topology diagram	128
Grouped smoke management devices	128
EN54 Spec label positioning	129
Battery disposal instructions	129
CE marking	130
NOTES	131

Contents

DOCUMENT UPDATE NOTES

S.No.	Release / Change Notes	Date
A	First Release	July 2019
B	Second Release	December 2019

PROPRIETARY NOTICE

All data and information contained within this manual is of a proprietary nature. Do not reproduce, transcribe, store in a retrieval system or translate into any language, any part of this manual without the prior permission of 'EATON'. EATON reserves the right to make changes to product specification without notice or liability. Every care has been taken to ensure the accuracy of the information contained in this manual, but no liability can be accepted for any errors or omission.

DISCLAIMER OF WARRANTIES AND LIMITATION OF LIABILITY

The information, recommendations, descriptions and safety notations in this document are based on Eaton Corporation's ("Eaton") experience and judgment and may not cover all contingencies. If further information is required, an Eaton sales office should be consulted. Sale of the product shown in this literature is subject to the terms and conditions outlined in appropriate Eaton selling policies or other contractual agreement between Eaton and the purchaser.

THERE ARE NO UNDERSTANDINGS, AGREEMENTS, WARRANTIES, EXPRESSED OR IMPLIED, INCLUDING WARRANTIES OF FITNESS FOR A PARTICULAR PURPOSE OR MERCHANTABILITY, OTHER THAN THOSE SPECIFICALLY SET OUT IN ANY EXISTING CONTRACT BETWEEN THE PARTIES. ANY SUCH CONTRACT STATES THE ENTIRE OBLIGATION OF EATON. THE CONTENTS OF THIS DOCUMENT SHALL NOT BECOME PART OF OR MODIFY ANY CONTRACT BETWEEN THE PARTIES.

In no event will Eaton be responsible to the purchaser or user in contract, in tort (including negligence), strict liability or otherwise for any special, indirect, incidental or consequential damage or loss whatsoever, including but not limited to damage or loss of use of equipment, plant or power system, cost of capital, loss of power, additional expenses in the use of existing power facilities, or claims against the purchaser or user by its customers resulting from the use of the information, recommendations and descriptions contained herein. The information contained in this manual is subject to change without notice.

SUPPORT SERVICES

The goal of Eaton is to ensure your greatest possible satisfaction with the operation of our products. We are dedicated to providing fast, friendly, and accurate assistance. That is why we offer you so many ways to get the support you need. Whether it is by phone, fax, or email, you can access Eaton's support information 24 hours a day, seven days a week. Our wide range of services is listed below. You should contact your local distributor for product pricing, availability, ordering, expediting and repairs.

Website

Use the Eaton website to find product information. You can also find information on local distributors or Eaton's sales offices.

www.eaton.com

EatonCare Customer Support Center

Call the EatonCare Support Center if you need assistance with placing an order, stock availability or proof of shipment, expediting an existing order, emergency shipments, product price information, returns other than warranty returns, and information on local distributors or sales offices.

Voice: 877-ETN-CARE (386-2273) (8:00 a.m. to 6:00 p.m. EST)

After-Hours Emergency: 800-543-7038 (6:00 p.m. to 8:00 a.m. EST)

Contents

Important Safety Information

Personnel who install, maintain or repair this equipment must read the safety information below before starting work.

Definitions and Symbols

WARNING

Indicates a potentially hazardous situation which, if not avoided, can result in serious injury or death.

CAUTION

Indicates a potentially hazardous situation which, if not avoided, can result in minor to moderate injury, or serious damage to the product.

General Safety Precautions

NOTICE

The operating system of the control panel may be revised as a result of enhancements to the system software or hardware. Revisions to this manual will be issued and supplied on request and should be logged in the table supplied on the contents page.

CAUTION

RISK OF EXPLOSION IF BATTERY IS REPLACED BY AN INCORRECT TYPE DISPOSE OF THE USED BATTERIES ACCORDING TO THE INSTRUCTIONS (Appendix page 129).

This product must only be disposed of in accordance with the WEEE directive.



Introduction

CF3000 provides all of the sophisticated features required of a leading edge analogue addressable fire system along with the simple operation and neat installation demanded by installers and building users.

The panel can be flush or surface mounted and the generously sized metal back box allows ample facilities for rear or top cable entries. It is available in single two and four loop versions, with or without an integral printer.

In addition both passive and fully functional repeater panels are available.

A comprehensive range of ancillary devices are available to operate with the panel, including Optical, photo-thermal and heat sensors, base mounted and stand alone sounders (including an IP67 version) a loop powered beacon and a wide range of interfaces.

Each of the components has been specifically designed to operate as part of a system, this provides an assurance that the panel, the sensors, the interfaces and the ancillaries are all fully compatible with each other and that the full range of system functionality is supported by each device.

Each loop of the control panel can accommodate up to 200 addresses, panels are available in one, two or four loop format. Up to 126 panels can be networked together to form a single system capable of operating with over 70,000 devices.

Project planning

The following is a typical program and timetable for an installation project, once the initial order has been received:

1. Project meeting

Installer and user to be present; system specifications, schematic diagram and proposed circuit drawing to be available. Installation & Commissioning Guide to be provided.

2. Equipment fix

Typically two week's notice is required for equipment to be delivered. Cable to be installed and bases/back boxes to be fitted. Then fire sensors, call points, alarm sounders, isolator units and interface units to be installed.

3. Address schedule

Schedule of sensor locations to be completed by installer and returned to enable System programming.

4. Auto learn

Fire panel/repeater panels to be installed and terminated. System to be powered up by installer and auto learn mode activated (see Auto Learn section). System to be tested and verified by installer, prior to final commissioning.

System design guidelines

5. Final commissioning

A minimum of two weeks notice is required from receipt of Address Schedule and Commissioning request form for a Eaton Service Engineer to attend site and implement/oversee the final commissioning procedures (see Commissioning section), in conjunction with the installer.

System design guidelines

Guidelines

Systems should be installed to the relevant local standards and codes of practice, for the UK this is BS5839 part 1. The panel meets all the relevant requirements of BS5839 part 1: 2017. Installation planning is simplified by the fact that every addressable device contains an integral short circuit isolator. Care must be taken to ensure that local standards requirements regarding aspects such as loop coverage, area covered by a single spur and cable specification are observed.

There may be certain applications in which deviations from the code may be necessary and these must be listed on the commissioning certificate. (See commissioning section)

Loop lengths

The maximum permitted loop length is 2 km measured from the near to the far terminals on the panel motherboard PCB. There is no minimum limit to loop length. Any wiring spurs off the loop must be included within the 2 km limit. On long loop runs, the lengths of wiring rises and falls (between floors, down to manual call points) must be included. Remember to include these especially when taking loop lengths from plan drawings.

Note: See loop loading system verification section below.

Loop loading - total number of addresses

The total number of addresses per loop is 200. this includes sensors, call points and all other addressable items. When designing systems its recommended that allowances are made for future expansion, Short circuit isolators are incorporated into every panel loop device, including Smoke sensors, heat sensors, sounders, callpoints and interfaces. Therefore, no further fault protection is required , in the event of a single fault, none of the devices connected to the loop will fail to operate as the fault will be isolated by the two adjacent devices. Spur connected devices downstream of a cable fault will cease to function.

Repeater Panels

Each repeater unit requires one address and consumes no more current from the loop than a smoke sensor. The repeater also requires a local mains supply and incorporates battery backup.

Loop Loading System Verification

Unless a loop loading calculation has already been carried out, please contact our technical support department (01302 303350), before starting installation to verify that a proposed loop loading arrangement is acceptable.

Compatible Equipment

Description	Dimensions (mm)			Product Codes	
	Length	Width	Height	Model Reference	Order Code
Addressable Control Panels					
Addressable 2 Loop Control Panel	180	497	397	CF3000	CF30002G
Addressable 2 Loop Control Panel c/w Network Card	180	497	397	CF3000	CF30002GNC
Addressable 2 Loop Control Panel c/w Integral Printer	180	497	397	CF3000	CF30002GP
Addressable 2 Loop Control Panel c/w Integral Printer, Network Card	180	497	397	CF3000	CF30002GPNC
Addressable 4 Loop Control Panel	180	497	397	CF3000	CF30004G
Addressable 4 Loop Control Panel c/w Network Card	180	497	397	CF3000	CF30004GNC
Addressable 4 Loop Control Panel c/w Integral Printer	180	497	397	CF3000	CF30004GP
Addressable 4 Loop Control Panel c/w Integral Printer, Network Card	180	497	397	CF3000	CF30004GPNC
Addressable Repeater Panels					
Addressable Passive Repeater	92	332	270	CF3000PRG	CF3000PRG
Addressable Passive Repeater c/w Network Card	92	332	270	CF3000PRGNC	CF3000PRGNC
Addressable Touch Screen Repeater	95	357	375	CTPR3000	CTPR3000
Addressable Detectors: Bases					
Addressable Detector Base	104	104	22	CAB300	CAB300
Addressable Detectors: Point					
Addressable Multi-Mode Heat Sensor	100	100	44	CAH330	400003FIRE-0003X
Addressable Optical Smoke Sensor	100	100	34	CAP320	400002FIRE-0002X
Addressable Photo-Thermal Sensor	100	100	44	CAPT340	400004FIRE-0004X
Addressable Detectors: Speciality					
Addressable Reflective Beam Detector 50-100m	120	130	210	MAB100R	MAB100R
Addressable Reflective Beam Detector 5-50m	120	130	210	MAB50R	MAB50R

Compatible Equipment

Description	Dimensions (mm)			Product Codes	
	Length	Width	Height	Model Reference	Order Code
Addressable Call Points					
Addressable Manual Call Point	53	87	87	CBG370S	CBG370S
Addressable Manual Call Point (Weatherproof)	53	87	87	CBG370WP	CBG370WP
Addressable Alarms and Beacons					
Addressable Remote Indicator	49	87	87	MRIAD	MRIAD
Addressable Beacon	53	95	95	CAB382	CAB382
Addressable Ceiling VAD (Red Plastic, Red Flash, Shallow Base)	37	93	93	CAB482CS	812037FULL-0214X
Addressable Wall VAD (Red Plastic, Red Flash, Deep Base)	66	93	93	CAB482WD	812036FULL-0212X
Addressable Wall VAD (Red Plastic, Red Flash, Shallow Base)	37	93	93	CAB482WS	812035FULL-0211X
Addressable Ceiling VAD (Red Plastic, White Flash, Shallow Base)	37	93	93	CAB492CS	812050FULL-0269X
Addressable Wall VAD (Red Plastic, White Flash, Deep Base)	66	93	93	CAB492WD	812034FULL-0210X
Addressable Wall VAD (Red Plastic, White Flash, Shallow Base)	37	93	93	CAB492WS	812033FULL-0209X
Addressable Sounder Base	40	102	102	CAS380	CAS380
Addressable Sounder Base (Australian Tone)	40	102	102	CAS380AU	CAS380AU
Addressable Wall Sounder	96	105	105	CAS381	CAS381
Addressable Wall Sounder (Australian Tone)	96	105	105	CAS381AU	CAS381AU
Addressable Wall Sounder (Weatherproof, Australian Tone)	103	109	108	CAS381AU-WP	CAS381AU-WP
Addressable Wall Sounder (Weatherproof)	103	109	108	CAS381WP	CAS381WP
Addressable Wall Sounder Beacon	95	105	105	CASB383	CASB383
Addressable Wall Sounder Beacon (Weatherproof)	105	108	108	CASB383-WP	CASB383-WP
Addressable Wall Sounder VAD (White Flash)	95	108	108	CASB393	CASB393
Addressable Wall Sounder VAD (Open Class, Weatherproof)	105	110	110	CASB393WP	CASB393WP
Addressable Wall Sounder VAD (Red Plastic, Red Flash)	92	106	147	CASB483	8500111FULL-0197X

Compatible Equipment

Description	Dimensions (mm)			Product Codes	
	Length	Width	Height	Model Reference	Order Code
Addressable Wall Sounder VAD (Red Plastic, White Flash, Weatherproof)	100	111	151	CASB483WP	8500115FULL-0201X
Addressable Wall Sounder VAD (Red Plastic, White Flash)	92	106	147	CASB493	8500110FULL-0199X
Addressable Wall Sounder VAD (Red Plastic, Red Flash, Weatherproof)	100	111	151	CASB493WP	8500114FULL-0200X
Addressable Sounder Beacon Base	44	115	115	CASBB384	CASBB384
Addressable Sounder Beacon Base (Bell Tone)	44	115	115	CASBB384-B	CASBB384-B
Addressable Sounder VAD Base (Open Class)	44	115	115	CASBB394	666129FULL-0198X
Addressable Interfaces					
Addressable Door Release Module	60	180	130	CIOP-7273	CIOP-7273
Addressable 4-20mA Interface	57	147	88	CGI420	CGI420
Addressable 3 Channel I/O Unit (Reset on Reset)	60	180	130	CIO351	CIO351
Addressable 3 Channel I/O Unit (Reset on Silence)	60	180	130	CIO351S	CIO351S
Addressable 3 Channel I/O Unit (Triple Address)	60	180	130	CIO351SST	CIO351SST
Addressable 4 Way Mimic Relay Board (4 In, 4 Out)	88	252	180	CIOP4	CIOP4
Addressable 8 Way Mimic Relay Board (4 In, 8 Out)	88	252	180	CIOP8	CIOP8
Addressable Micro Zone Monitor Unit	18.5	35	65	CIU872	CIU872
Addressable 230V Relay I/O Unit	60	180	130	CMIO353	CMIO353
Addressable 4-Way Sounder Controller	74	300	300	CSC354CPR	CSC354CPR
Addressable Spur Isolator Unit	60	147	88	CSI350	CSI350
Addressable Zone Monitor Unit	60	147	88	CZMU352	CZMU352
Addressable Zone Monitor Unit (Intrinsically Safe)	60	147	88	CZMU352-IS	CZMU352-IS

Compatible Equipment

Description	Dimensions (mm)			Product Codes	
	Length	Width	Height	Model Reference	Order Code
Addressable Fan Controller (18 Channel, 19 " Rack Mount)	33	482	133	FC18	FC18
Addressable Fan Controller (6 Channel, Surface Mount)	43	161	126	FC6	FC6
Addressable Micro Single Channel Input Unit	18.5	35	65	MCIM	MCIM
Addressable Micro Single Channel Output Unit	18.5	35	65	MCOM	MCOM
Addressable Micro Single Channel Output Unit (Fan Controller)	18.5	35	65	MCOM-FC	MCOM-FC
Addressable Micro Single Channel Output Unit (Reset on Reset)	18.5	35	65	MCOM-R	MCOM-R
Addressable Micro Single Channel Output Unit (Sounder)	18.5	35	65	MCOM-S	MCOM-S
Addressable Shop Unit Monitor	57	147	88	MSU840	MSU840
Addressable Network and BMS					
Single Mode Lon to Fibre Optic Adapter	43	136	116	CFSFL01	CFSFL01
Dual Channel Lon to Fibre Optic Adapter	43	136	116	CFSFL02	CFSFL02
Lon to RS232 Adapter (connects panel network to PC)	135	116	36	EC0232	EC0232
Dual Channel LonWorks BMS Interface	58	105	86	EC200	EC200
Dual Channel LonWorks BMS Interface (for EC700)	58	105	86	EC200S	EC200S
Addressable TCP/IP Interface	73	105	100	EC400	EC400
Addressable Lon Network Booster	73	110	106	EC540	EC540
Addressable BACnet Interface	73	110	106	EC650B	EC650B
Addressable Modbus Interface	120	75	27	EC700	EC700
Addressable System Software					
Graphical Visualisation Software - 10+ Panels c/w EC0232 interface	N/A	N/A	N/A	EFGVS11-PLUS	EFGVS11-PLUS
Graphical Visualisation Software - 10+ Panels c/w TCP/IP interlink	N/A	N/A	N/A	EFGVS11-PLUS-TCP/IP	EFGVS11-PLUS-TCP/IP
Graphical Visualisation Software - Up to 2 Panels c/w EC0232 interface	N/A	N/A	N/A	EFGVS1-2	EFGVS1-2
Graphical Visualisation Software - Up to 6 Panels c/w EC0232 interface	N/A	N/A	N/A	EFGVS3-6	EFGVS3-6

Compatible Equipment

Description	Dimensions (mm)			Product Codes	
	Length	Width	Height	Model Reference	Order Code
Graphical Visualisation Software - Up to 10 Panels c/w EC0232 interface	N/A	N/A	N/A	EFGVS7-10	EFGVS7-10
Graphical Visualisation Software - Up to 10 Panels c/w TCP/IP interlink	N/A	N/A	N/A	EFGVS7-10-TCPIP	EFGVS7-10-TCPIP
Graphical Visualisation Software - Designer, no panel connectivity	N/A	N/A	N/A	EFGVS-DESIGN	EFGVS-DESIGN
Graphical Visualisation Software - Premium Designer c/w EC0232 interface	N/A	N/A	N/A	EFGVS-PREMIUMDESIGN	EFGVS-PREMIUMDESIGN
Sitemonitor/Webserver Software c/w EC0232 interface	N/A	N/A	N/A	EF-SITEMONITOR	EF-SITEMONITOR
Conventional Alarms and Beacons					
Conventional Remote Indicator	30	87	87	CIR301	CIR301
Conventional Remote Indicator (Weatherproof)	30	87	87	CIR301WP	CIR301WP
Installation Accessories					
Safety Power Supply (24V/1.5A)	175	300	22	SPS-2423	SPS-2423
Safety Power Supply (24V/2.5A)	175	300	22	SPS-2433	SPS-2433
Safety Power Supply (24V/4.5A)	175	300	22	SPS-2453	SPS-2453
Addressable Control Panel Spare Parts					
Addressable Loop Splitter Unit	102	132	34	ZPCB2222	ZPCB2222
Addressable Loop Mimic LED PCB (Master)	140	290	20	ZPCB2252-MML	ZPCB2252-MML
Addressable Loop Mimic LED PCB (Slave)	140	290	20	ZPCB2252-MSL	ZPCB2252-MSL

Compatible Equipment

The range of compatible sensors for the control panel system consists of the following:

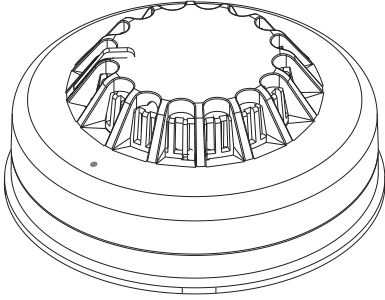

Addressable Optical Detector, this is the most commonly used detector and is most suitable for detecting slow burning fires.

The status LED can be programmed to either be permanently off under normal conditions or to pulse in order to confirm that it is in communication with the control panel.

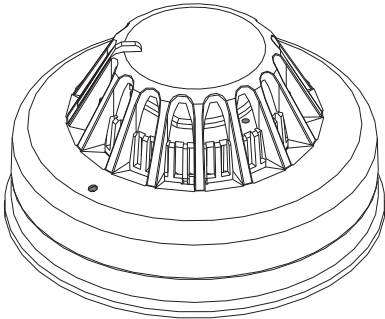

Addressable Photo Thermal Detector, this is the ideal detector for a multi-use environment as it has an excellent response to smouldering and fast burning fires. Photo/thermal detectors can be programmed for thermal only operation at certain times of day.

The status LED can be programmed to either be permanently off under normal conditions or to pulse in order to confirm that it is in communication with the control panel.

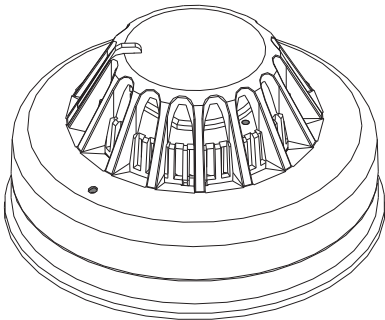

Addressable Heat Sensor, this is suitable for dusty environments or environments where smoke is likely to be present under normal operating conditions. The heat detector can be programmed to operate in A1R,BS or CS mode of operation depending on the required application and sensitivity requirements.

The status LED can be programmed to either be permanently off under normal conditions or to pulse in order to confirm that it is in communication with the control panel.

Compatible callpoints

The range of purpose designed callpoints consists of a surface callpoint and a surface weatherproof callpoint.

A range of accessories is available including a hinged protective cover, resettable element kit and a flush bezel.

The status LED can be programmed to either be permanently off under normal conditions or to pulse in order to confirm that it is in communication with the control panel.

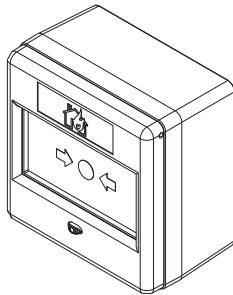

CBG370S

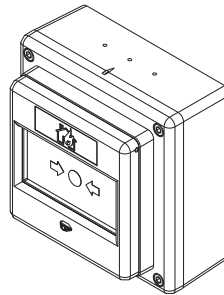

CBG370WP

Compatible sounders and beacons

A wide range of loop powered sounders and beacons are available to operate with the control panel, consisting of a combined sounder base with a maximum output of 95 dB(A), a standalone sounder with a maximum output of 100 dB(A) that is available in standard or weatherproof versions and a stand alone loop powered beacon.

For applications where a discreet dedicated sounder is required, a cover plate is available for the white base mounted sounder enabling it to be used as a stand alone wall or ceiling mounted sounder.

All of these devices are fully programmable via the sophisticated multi-stage cause and effect programming facilities.

All sounders have multiple selectable volume settings, the volume setting is controlled by the panel and so can be altered without needing to access the sounder.

Compatible Equipment

Base sounder

The CAS380 has been designed specifically to complement the latest generation of Eaton Fire Systems soft addressed detectors. It consists of a first fix bracket, and a main body which clips onto the bracket incorporating the sounder and a detector mounting base in a single composite assembly.

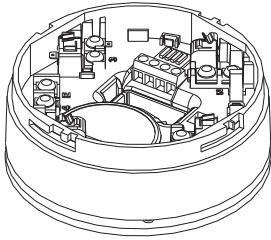

CAS380

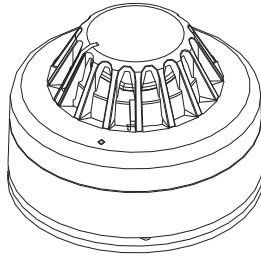

CAS380 with Sensor fitted

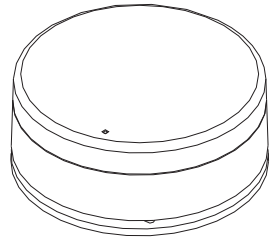

CAS380 with CASC fitted

After the body has been clicked into place and connected, a detector or front cover is then added to complete a very simple quick and neat installation. The cover enables the CAS380 to be used as a discreet stand alone wall or ceiling mounted device. The sounder base design incorporates a mechanism that can be activated if required to lock either the detector or the cover into place to prevent unauthorised removal.

Base sounder beacon

The CASBB384 has been designed with the same fixing as the CAS380 so it can accommodate either a detector or front cover being fitted.

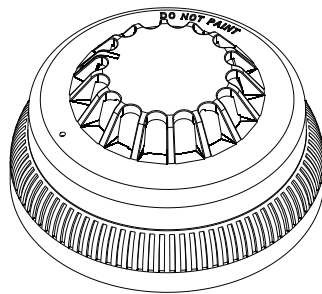

Visual Alarm Devices (VADs)

A range of loop powered VADs are available for applications where visual alarm indications is required. These include areas of high ambient noise, or buildings which are used by people who are hard of hearing. Each product in this range provides both audible and visual indication of a fire alarm. The range consists of a VAD base and two wall sounders. The CASBB394 has been designed with the same fixing as the CAS380 so it can accommodate either a detector or front cover being fitted

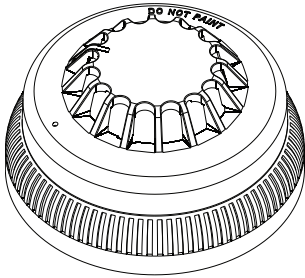

CASBB394 with Sensor fitted

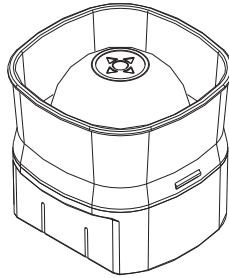

CASB393

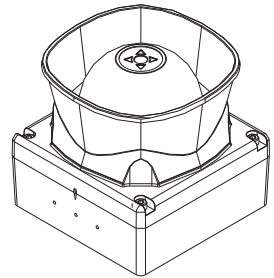

CASB393WP

Loop powered beacon

A loop powered flashing beacon is available for applications where visual alarm indication is required such as areas of high ambient noise or buildings which are used by people who are hard of hearing.

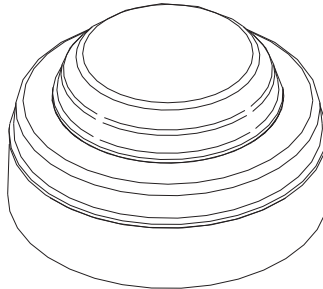

CAB382

Compatible Equipment

Dedicated stand alone sounders

Stand alone sounders are ideal for applications where greater sound outputs are required than can be achieved with a base sounder or for applications requiring a higher level of resilience or ingress protection.

Two different versions are available standard version and an IP66 rated version.

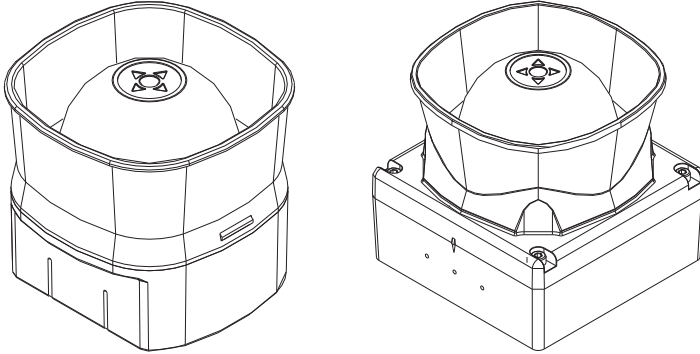

Interfaces

The control panel has been designed to be suitable for a wide range of applications, various interfaces have been developed to enable the simple integration of other fire systems or building control and safety systems. The following devices are available:

3 channel I/O devices

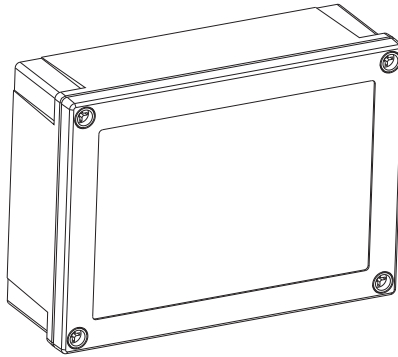

CIO351

CIO351

CIO351 has 3 input channels and 3 output channels, it is used to monitor up to three separate inputs from equipment such as sprinkler flow switches and also to provide 3 separately controlled volt free output contacts which are intended to be used to control external equipment such as air handling plant or access control systems.

All inputs and outputs operate completely independently of each other and can be programmed using the sophisticated cause and effect capabilities to operate either globally or in response to activation of specific devices or specific inputs.

Inputs are monitored for open and short circuits, a specific resistance is required to activate an alarm condition, fully open or short circuit conditions are monitored and generate a system fault signal.

Inputs are suitable for use as fire signal inputs such as from a sprinkler flow switch, however they can also be used to monitor non fire inputs such as external keyswitches. Outputs are rated to switch a maximum of 1A resistive at 30V DC.

CIO351SST (CIO351T)

This unit is identical in build to the CIO351 but this has been designed to take 3 addresses (this can be expensive in terms of outputs because it replies as 3 x 3Chan I/O's), this means that text information can be allocated to each channel. It also allows each individual input and output to be disabled (by address). The maximum number of addressable CIO351SST per loop is 3.

Compatible Equipment

CIO351S

Once again this unit is identical with the CIO351 only taking 1 address. The programming is the same as the CIO351. This unit was designed so that the relay outputs reset on silence rather than full reset, thus enabling the user to interface this device with other fire panels and hence prevents locking up. The maximum number of addressable CIO351S per loop is 20.

1 channel I/O device with mains rated switching

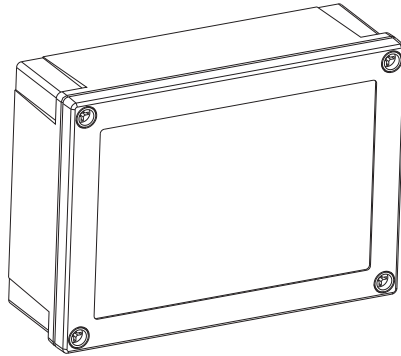

CMIO353

CMIO353 is a single channel input / output unit, the output is capable of switching up to 8A at 230V AC.

Commonly used for applications such as door release controls and plant shut down signalling.

The input is monitored for open and short circuits, a specific resistance is required to activate an alarm condition, fully open or short circuit conditions are monitored and generate a system fault signal.

The input is suitable for use as a fire signal input such as from a sprinkler flow switch, however it can also be used to monitor non fire inputs such as an external keyswitch.

Zone monitor units

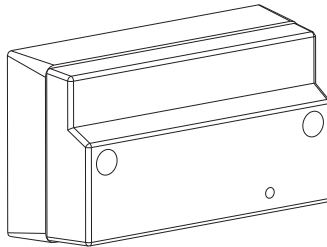

CZMU352

CZMU352 is designed to enable a zone of compatible conventional detectors and callpoints to be connected into the addressable loop, it is compatible with up to 20 Eaton conventional detectors connected via CDBB300 bases.

Please refer to local standards e.g. BS5839 Pt1:2017 for details of the maximum allowable area to be covered by a single spur / zone. CZMU352 fixes to a standard, deep, double gang back box and can be either surface or semi recess mounted. When semi recessed only the front section protrudes giving a maximum 29mm depth.

CZMU352-IS

CZMU352-IS Similar to the above but the detection zone has been programmed to accept a Zener barrier and a zone of 10 intrinsically safe detectors. End of line for this zone now becomes 6K8 and the diode in the detector base must be removed. The maximum number of addressable CZMUs per loop is 20.

Shop unit interface

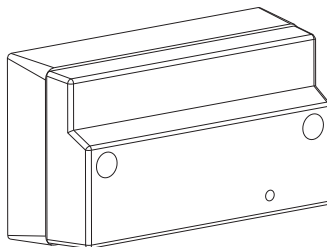

MSU840

MSU840 accepts a zone of conventional detectors plus an unlimited number of callpoints which can be connected to the same input as the detectors or a separate callpoint input if required. It also has a 24V 1A rated relay output, and a facility to connect a power supply, which can then be monitored for fault. In addition it has the facility to connect two circuits of conventional polarised sounders, which are monitored by means of an end of line resistor and powered in alarm conditions from

Compatible Equipment

the external power supply.

The sounder circuits can be programmed to operate in pulsed, continuous or time delayed mode.

Please refer to local standards e.g. BS5839 Pt1:2002 for details of the maximum allowable area to be covered by a single spur / zone. The maximum number of addressable MSUs per loop is 20.

Spur isolator

CSI350 enables soft addressing to work when the loop contains spurs, it controls the addressing operation so that when the system reaches a spur, all devices on the spur are allocated an address before it continues addressing the loop. CSI350 is mounted on a standard deep double gang back box (supplied).

The device also incorporates a short circuit isolator. Because each device contains a short circuit isolator only 1 is required at the start of each spur.

Please refer to BS5839 Pt1:2017 for details of the maximum allowable area to be covered by a single spur/zone.

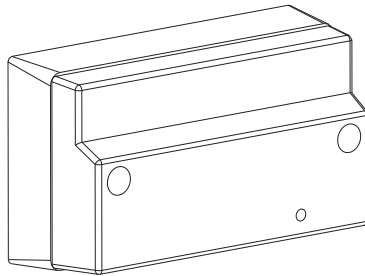

CSI350

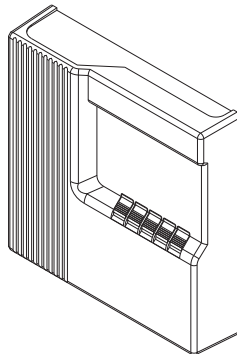

CSC354CPR

4 way sounder circuit controller

CSC354CPR provides power for 4 separately controllable conventional sounder circuits, each circuit can be separately programmed. It has been designed to greatly simplify installation in applications where specialist sounders or beacons are required since it powers the sounders and allows full control of the sounder operation without having to wire the sounder back to the control panel. A 4 way unit takes up a single address but each circuit can be independently controlled.

An CSC354CPR unit requires a local un-switched 230V supply and incorporates a back up battery to 24 hours of standby operation followed by a minimum of 30 minutes of full alarm ringing.

A standby of 72 hours can be achieved at the expense of reduced load capability.

4-20mA interfaces

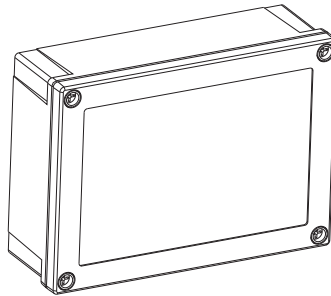

CGI420, CGI420R

CGI420

This is a 4 to 20mA module designed to interface with gas detection modules.

This interface takes 1 address on the loop and has built in short circuit isolators.

DIL switches are provided on the interface to allow the threshold levels for pre-alarm1, pre-alarm2 and alarm to be programmed. These can be expressed as percentage of L.E.L (lower explosion limit) or PPM (parts per million).

This interface requires an external power supply.

CGI420R

This module is the same as the CGI420 but also comes with a relay output.

Compatible Equipment

Micro interfaces

A range of micro interfaces modules are also available:

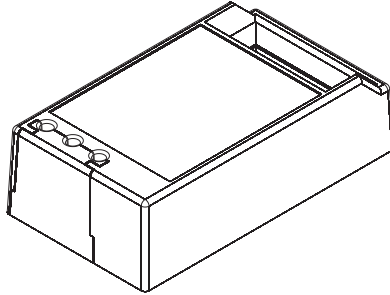

MIU872 is a compact single zone input, soft addressed, microinterface, incorporating integral short circuit isolators. It is fully compatible with the current range of Eaton analogue fire detection panels. It is suitable for interfacing a zone of up to 20 conventional Eaton detectors onto a Eaton analogue fire panel. It will operate with any Eaton conventional detector in configuration with a schottky diode type base.

400008FIRE-0022X (MCIM) is a compact input module used to accept input signals from external equipment such as beam detectors, flow switches, valve monitor switches etc. The panel can be programmed to perform different actions based on the state of the input. The maximum number of input devices per loop is 200.

400010FIRE-0024X (MCOM) is a compact single channel output unit for general external equipment control. This device is identified as an I/O device by a Eaton addressable panel. The maximum number of I/O devices per loop is 20.

400012FIRE-0026X (MCOM-S) is a compact single channel output unit. This device is identified as a sounder output by a Eaton addressable panel and will react to evacuate commands. The maximum number of sounder devices per loop is 60.

400011FIRE-0025X (MCOM-R) is a compact single channel output unit used to control or signal external equipment which require removal of power for reset purposes. This device is identified as an I/O device by a Eaton addressable panel. The maximum number of I/O devices per loop is 20.

MCOM-FC is a compact single channel output unit used in conjunction with the Fan Controller (FC6/FC18) for the control of smoke extraction fans. This device is identified as a sounder output by a Eaton addressable panel but does not react to the evacuate command. The maximum number of sounder devices per loop is 60.

Technical input/output unit

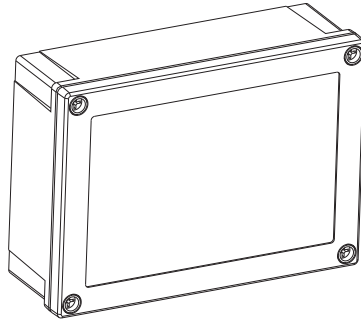

CFC301 is a fan control and feedback device in one unit that is used in conjunction with the Fan Controller (FC6/FC18) for smoke extraction applications.

The CFC301 takes 2 addresses on the loop, one for the fan control which addresses as a Zone Monitor Unit and one for the fan feedback which addresses as a Technical Input.

The fan control output is performed by a volt-free contact that allows a 30V signal to be switched to the extraction fan.

The fan feedback input is monitored for open and short circuits on the cable between the unit and the extraction fan using an end-of-line resistance at the fan itself. All fault conditions are reported by to the Fan Controller (FC6/FC18) and the fire panel. A specific resistance is must be placed in parallel to the end-of-line resistor to report the fan is in the active condition and removed to report the fan is in the inactive condition.

Compatible Equipment

Fan controller interfaces

(FC6, FC18)

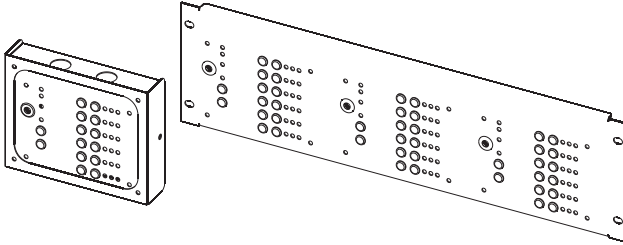

FC6 and FC18 Interface are designed to work with the Eaton range of analogue fire alarm control panels, providing the capability to control and display the status of AHU fans.

FC6 and FC18 Interface is connected to a Eaton analogue addressable fire alarm control panel by means of the comms loop, utilizing only one address whilst providing the ability to monitor and control up to six AHU Fans.

Each FC6 and FC18 Interface incorporates its own CPU specifically configured to control the relevant input and output logic making programming quick and easy via the site installer software.

Using the site installer software, each individual Fan Control channel on the FC6 is programmed to an output and feedback input field device to control and monitor the status of an AHU fan.

Features:

- Convenient loop mounting
- Comprehensive LED display
- Surface/rack mounting options
- Key operated auto/manual operation
- Comprehensive software cause and effect

Compatible fan control and feedback devices:

- MCIM configured as a technical input for independent fan control feedback
- MCOM, MCOM-S, MCOM-FC for independent fan control
- CFC301 for combined fan control and fan control feedback
- FC6 has 1 address. FC18 has 3 addresses.

Equipment compatibility

Sensors

Loop wired sensors must be of the Eaton Fire Systems soft addressed analogue type. Eaton Fire Systems conventional detectors can be connected via an CZMU352 interface. The connection of other detector types via an CZMU352 interface is not recommended.

Call points

Loop wired call points must be the Eaton Fire Systems soft addressed analogue type, Eaton Fire Systems conventional callpoints can be connected via an CZMU352 interface. The connection of other callpoint types via an CZMU352 interface is not recommended,

Sounders

Loop powered addressable sounders must be of the Eaton Fire Systems soft addressed analogue type.

Conventional sounders can also be connected either to the conventional sounder circuits at the panel or to the loop via a CSC354 addressable sounder controller interface providing they meet the following:

- They are suitable for operation between 18V and 28V
- They are polarised and suppressed
- The total alarm load is less than the rating of the panel/Alarm Power Interface

Note: It is possible to use devices outside these requirements if they are supplied with power from a separate source and switched via a suitable relay.

Relay circuits

Additional relays can be added to the system by using either CMIO353 or CIO351 relay units.

Equipment compatibility

Relays/auto-dialers and auxiliary equipment

A wide variety of relays and other equipment can be connected to the system, but you should note the following constraints:

- The panel provides monitored outputs to drive fire and fault relays mounted in external equipment. External relays should be suppressed. If a non-suppressed relay is used then a diode can be connected to suppress any reverse EMF on the release of the relay which might cause the panel to malfunction
- A 24V DC output is provided at the panel to make it easy to connect ancillary equipment. Although the panel can supply a continuous quiescent load of up to 30mA, BS5839 precludes this practice and any ancillary equipment you connect should only consume power in the alarm or fault mode to meet the requirements of BS5839

Additional instructions for electromagnetic compatibility

When used as intended this product complies with EMC Directive (89/336/EEC) and the UK EMC regulations 1992 (SI 2372/1992) by meeting the limits set by the standards BS 5406 (Pts 2&3) 1988, EN50130-4 immunity and EN 61000-6-3 emission requirements.

The following installation guidelines must be followed.

- External cables must be connected using the cable entries or knockouts provided.
- When routing external cables inside the product they must be
 - Kept as short as possible
 - Routed close to the housing
 - Kept as far as possible from the electronics

Any modifications other than those stated in this manual, or any other use of this product may cause interference and it is the responsibility of the user to comply with the EMC and Low Voltage Directives.

System overview

Simple user interface

The main element of the user interface is a large (120mm x 90mm visible area) touch screen display, which provides comprehensive user information and also acts as a multifunctional keypad.

Comprehensive context sensitive help information is provided throughout the menus to assist unfamiliar users with system operation.

The touch screen display automatically reconfigures to suit the selected function, for example, if the change device text menu option is selected, the touch screen is automatically formatted as a full QWERTY keyboard to enable fast and simple text entry.

The use of the touch screen display enables a wide range of user and engineering facilities to be incorporated into the panel whilst still offering simple operation.

As well as a large format LCD display providing full system status information, the panel incorporates 96 traditional zone indication LED's to provide clear information about the status and spread of a fire even to a user who is completely unfamiliar with the operation of the system.

In addition there are a number of system status LED's designed to give clear status information to non technical users.

User configuration and maintenance facilities

The control panel has comprehensive facilities for on site system configuration, whereby the user can add or remove simple devices or change device text directly via the panel, without the need for a service engineer to visit site. For initial configuration or major system changes special PC configuration software is available enabling Eaton Service personnel to do this more efficiently than can be achieved using the system screen. Existing configurations can be uploaded to the PC so that changes can be made to the existing system rather than having to revert to initial files.

Sophisticated sounder control facilities

The control panel has the ability to support highly complex ringing pattern requirements. Multistage cause and effect programming is possible whereby each addressable sounder or output interface can be programmed independently if required and can be set to respond to specific addresses, specific detection zones, specific panels on a networked system or standard global ringing.

The panel supports three separate sets of programming per sounder and each stage can be triggered differently. For example, if a single sensor is triggered, the panel can be programmed so that the sounder nearest to the sensor operates immediately and continuously. The remaining sounders in the affected zone operate in pulsed mode, and the other sounders delay for a selectable period. This allows the cause of the alarm to be investigated before global ringing commences.

System overview

Spur tolerant soft addressing

The control panel utilises intelligent soft addressing technology to greatly simplify the installation and commissioning processes.

Once the system has been installed and the autolearn menu selected, the control panel will automatically scan the detection loops and allocate each device with an address number corresponding with its position on the loop, this avoids the traditional need for manual addressing of the system devices which is time consuming and provides a potential for error.

A major innovation is the ability to incorporate spurs of analogue devices which are fed from the main loop by utilising a spur isolator. Whenever the panel detects a spur, it breaks from allocating address numbers to the loop wired devices, allocates address numbers to each of the devices on the spur in sequence and then continues to address the devices on the main loop.

Every analogue device incorporates an integral short circuit isolator ensuring maximum system integrity. A single short circuit will not disable any loop-mounted devices, the isolators in the devices each side of the short circuit will operate and the control panel will drive communication from both ends of the loop.

The spur isolator also incorporates a short circuit isolator such that in the event of a short circuit on the spur, the integrity of the main loop will not be compromised. Please refer to local standards e.g. BS5839 Pt1:2017 for details of the maximum allowable are to be covered by a single spur.

Simple future expansion

The system is designed to ensure simplicity of future expansion. If an additional device is added after the system has been programmed, the control panel will allocate the next available address, it will not alter any of the existing address numbers allocation thus enabling simple updating of as fitted drawings etc.

Similarly if a device is removed, the relevant address is saved as a spare address for future use, the addresses of the remaining devices are not altered.

Integral power supply and battery

The panel is designed for ease of installation, the power supply and battery are integral to the main control panel so only a single panel is required even on large 4 loop systems.

Systems are available with either standard or extended capacity battery configurations. Where system loading and standby period requirements necessitate an extended capacity battery, a deeper backbox is utilised thus avoiding the need for a separate battery enclosure.

The charger is suitable for both standard and extended capacity batteries.

Optional printer

The control panels are available with optional built in printers.

Where a printer is fitted, it is housed behind a printer cover door, which can be opened by means of a special tool (Supplied) to provide simple and safe access to the printer paper roll without exposure to any live equipment.

Paper replacement is extremely simple due to the drop in loading method and auto feed printer design, the paper roll is simply dropped into the purpose designed cradle and the end of the roll is then offered up to the printer, which will then automatically load the paper ready for use.

The printer can be set to either print automatically or to print on demand when a printer is not fitted, a removable, flush fitting blanking plate is used to cover the printer paper aperture to enhance the appearance of the panel and to preserve its ingress protection rating.

Hinged lockable cover

With a standard panel, access to all panel functions is controlled by a series of pass codes, which are entered via the touch screen display, for maximum security, a facility is built into the panel to enable the user to alter the user pass code as required. To provide a high level of resilience, a clear hinged lockable front cover is available which allows the screen and all of the system status indicators to be clearly seen but prevents access without first unlocking the cover.

A single concealed locking mechanism provides access to both the printer door and the display cover. Additional buttons are provided to scroll the display and to silence the fault buzzer without opening the lockable cover.

Technical specification

Technical specification

Power supply (Approved EN54 pt 4)

Mains

Nominal voltage	230 Vac + 10%, -15% 50/60 Hz	
Nominal current	75mA	
Maximum current	750mA	
Input fuse R1	NTC SG39 I _{max} 4Amp	
Output voltage including tolerances	26V	18.5 to 29.5Volts
	26V RAW	18.5 to 29.5Volts
	5Volt Output	4.6V to 5.5V
Ripple voltages	26V	800mV
	26V RAW	800mV
	5Volt Output	430mV
Maximum loadings	26V O/P	0.98A
	26V RAW O/P	1.7A
	5V	0.5A
Standby current (4 Loops loaded)	26V	280mA
	26V RAW	150mA
	26V	280mA
	26V RAW	150mA
	5V	43mA

The panel is protected by an internal thermal device, this requires no maintenance

* I max a, I max b & I min = Current as specified in BSEN54-4 Published 2006 (Amendments 1 & 2)

Batteries

Number of Batteries	2
Manufacturer:	YUASA NP12-12
Capacity	12 Ah
Battery Fuse	6.3A Anti-Surge (F4)
Maximum battery current	3.5 Amps
Standby current (mA)	175 (4 loops), 125 (2 loops)
Maximum charging current to the batteries	1.0amp
Float Voltage	27.4 Volts
Final Voltage	21.0Volts
Charging characteristics	Constant voltage with 0.970A limit with temperature compensation
Maximum current drawn from the batteries when the mains is not available	3.5Amps

Deep discharge protection	20.6 Volts
Battery internal impedance Fault	>0.5 ohms

Inputs

Addressable loops

Max number	1 - 4
Max loop load per loop	220 ma (recommended)*
Max number of addressable devices per loop	200
Class change	Operated by external volt free contact

*Max value is 350 ma, but loop loading should be confirmed via Loop Calculator software depending on the type of hardware being used.

Outputs

Conventional sounder circuits

Number of sounder circuits	4
Total sounder Load	1.5 Amps
Sounder circuit fuses (F1/2/3/4)	1.6 Amp (Quick Blow)
End of line resistor	6k8

Fire protecting equipment

Max Load	60 ma
Fused (PTC3)	100mA polyswitch
End of Line resistor	6k8

Fault routing equipment

Max Load	30 ma
Fused (PTC1)	100mA polyswitch
End of Line resistor	6k8

Technical specification

Auxiliary relays

The auxiliary relays provide fused volt free change over contacts. These contacts are not monitored.

Max Load	24 Volts 1 Amp
Fuse (PTC4)	1.35 Amps polyswitch

Auxiliary 24V supply

Nominal Voltage	24 Volts $\pm 10\%$
Fuse (PTC5)	100 mA Polyswitch
Maximum current	30 mA

This output is not to be used for Fire protecting equipment or Fire alarm routing Equipment Any power taken from the alarm system will effect the standby duration.

Terminal blocks: Do not use excessive force when tightening the screws on the terminal block

Printer (Optional)

Type	High speed thermal
Number of characters per Line	40
Type of paper	58mm x 46mm Thermal Roll
Replacement paper roll order code	ADF6PRINTERPAPER

Mechanical specification

Weight including batteries	18Kg
Weight excluding batteries	9Kg
Dimensions (Standard batteries)	495mm(L) x 395mm(H) x 180mm(D)
Type of Material (backbox)	Mild steel (Power coated)
Type of Material (Facia)	PC/ABS
Flammability Rating	UL 94 V0
Total Number of knockouts	51
Diameter of Knock out	20mm

Anti-tamper cover (Optional)

Weight	250g
Material used	Poly Carbonate
Flammability rating	UL 94 5VA

 **CAUTION**

Risk of explosion if battery is replaced by an incorrect type dispose of the used batteries according to the instructions.

Technical specification

Optional functions as per EN54 P2&4

The panel is approved to EN54 Parts 2 & 4 including all the following options which can be selected as required

Panel outputs

Panel Sounders: (OPTION 7.8 EN54 PT 2)

Two pairs of outputs are provided. ONLY polarised equipment should be used. Ensure the polarity of the connections are observed at all times and end of line resistors (6K8 5%) are fitted for correct operation.

The total alarm load across all sounder outputs = 1.5 Amp

All outputs are fused with 1.6 Amp Glass fuse Alarm devices should be spread equally across the 4 sounder circuits.

WARNING

Do not exceed the rated output current

Output fire alarm routing equipment

(Option 7.9 EN54 PT 2)

This output, which is fused, and monitored using a 6.8k end of line resistor, is used for the automatic transmission of the fire signals to fire alarm routing equipment (e.g. Fire brigade). It operates by providing 24 Volt output to an auxiliary device (e.g. relay).

It is current limited to 30 mA using a resettable polyswitch. Class change and test conditions do not operate this output. If operated under a fire alarm condition, the indication will be displayed on the Touch screen display and will remain until the fire alarm is reset.

Ensure the polarity of the connections are observed at all times and end of line resistors (6K8 5%) are fitted for correct operation.

Output to fire alarm protecting equipment

(Option 7.10 EN54 PT 2)

This output, which is fused, and monitored using a 6.8k end of line resistors used for the transmission of the fire signals to controls for automatic fire protecting equipment (e.g. Door released units etc).It operates by providing 24 Volt output to an auxiliary device (e.g. relay).

It is current limited to 30 mA using a resettable. polyswitch. Class change and test conditions do not operate this output. If operated under a fire alarm condition , this output remains energised until the fire alarm is reset.

Ensure the polarity of the connections is observed at all times and end of line resistors (6K8 5%) are fitted for correct operation.

Output to fault warning routing equipment

(Option 9.4.1C EN54 PT 2)

This output, which is fused and monitored using 6.8k end of line resistor, is used for the transmission of fault signals to fault warning routing equipment. This output is monitored using 6k8 end of line resistor and its current is limited to 30 mA. Under normal conditions it operates by providing 12VDC which can be connected directly to a 12V auxiliary device (relay). It is current limited to 30 mA.

Under fault conditions or even if the panel is powered down, this output will switch to 0 volts. Ensure the polarity of the connections is observed at all times and end of line resistors (6K8 5%) are fitted for correct operation.

Delays to outputs

(Option 7.11 of EN54pt 2)

The panel has the option to delay the operation of panel sounders, the fire routing equipment output and the fire protecting equipment. This delay is selectable using the site installer download software. The delay is configurable in increments of 1 minute up to a maximum of 10 minutes.

This delay can be enabled and disabled at access level 2.

The panel has the facility for a specific call point to override this delay by programming this call point via an input interface to provide an evacuate signal using site installer.

Coincidence detection

(Option 7.12 of EN54 pt 2)

The panel has the facility to inhibit the operation of the output sounders, Output to Fire routing equipment and the output of the fire protecting equipment until one more confirmatory signal is received from different zones. This feature is programmable using Site Installer Software.

Alarm counter

(Option 7.13 EN54 PT 2)

The panel records the number of instances that it enters the fire alarm condition. This is abbreviated in the touch screen by "AC" and it is displayed in the fire window at access level 2. This counter can only be reset by the manufacturer.

Technical specification

Optional auxiliary board VDS requirement

(Option not required by EN54)

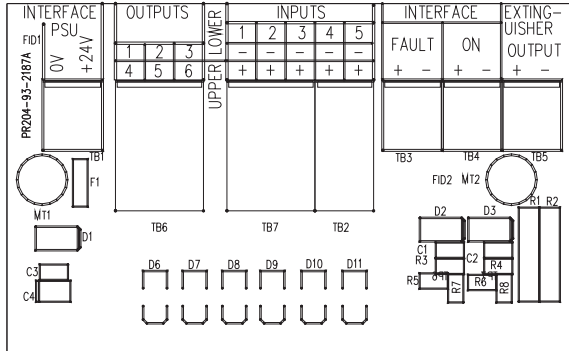

This board can be connected to an Extinguishing system as well as a Fire Brigade Control Panel. This board has been tested and approved in according with DIN14661 and DIN 14675.

Optional functions as per EN54 P2&4

Inputs/outputs to the fire brigade panel

Outputs

- Output 1: Fire protecting equipment operated “Extinguishing On”

This output is ON in alarm condition to indicate that the Control and indicating equipment has operated the fire protecting equipment (option 7.10 of EN54 pt2)

- Output 2: Fire Routing Equipment operated “Fire Brigade Link”

This output is ON in alarm condition to indicate that the Control and indicating equipment has operated the fire routing equipment (option 7.9 of EN54 pt2).

- Output 3: Disablement of Fire Protecting Equipment

This output is ON to indicate that the fire Protecting equipment has been disabled either by the control and indicating equipment or the Fire Brigade Panel.

- Output 4: Disablement of the Fire Routing Equipment

This output is ON to indicator that the fire routing equipment has been disabled either by the control and indicating equipment or the Fire Brigade Panel.

- Output 5: Reset from Fire Alarm Condition

This output is ON to indicate that the control and indicating Equipment is in alarm condition. This output will remain on for at least 15mins after reset or when the reset has been activated from the Fire Alarm Brigade Panel

- Output 6: Disablement of Sounders

This output is ON to indicate that the sounders have been disabled either by the control and indicating equipment or the Fire Brigade Panel.

Inputs

- Input 1: Reset

This input is used to reset the control and indicating equipment.

- Input 2: Testing of Fire Routing Equipment

This input is used to test the output to the fire routing equipment.

- Input 3: Disablement of the Fire Routing Equipment

This input is used to disable the fire routing equipment output of the panel. Whilst the FRE is disabled by this input, it can not be re-enabled by the control panel.

- Input 4: Disablement of the Fire Protecting Equipment

This input is used to disable the fire protecting equipment output of the panel. Whilst the FRE is disabled by this input, it can not be re-enabled by the control panel.

- Input 5: Disablement of Sounders

This input is used to disable the sounders of the control panel. The disablement of sounders from the Fire Brigade Panel can be re-enabled from the control panel only when the system is not in Alarm State.

German interface electrical characteristics:->

Inputs

The inputs are designed to be actioned in one of two ways, see list below:

First - a change in logic state ie. Switch toggled on / off.

Second - logic pulse ie. nominal state logic high, then logic low > 200mS then return to logic high.

All inputs are held high via a weak pull up (logic high), the action of short circuiting any of the five inputs to there respective 0v will result in a logic low.

1. Reset -> Logic pulse
2. FRE relay test -> Logic pulse
3. FPE disable -> Logic state change
4. FRE disable -> Logic state change
5. Acoustic disable -> Pulse logic

Monitored inputs

In Fault/extinguisher active

- End Of Line resistor 3K3
- 680 Ohm across input to activate input

Relay outputs

- Normal status-> input sees a 3K3 resistor
- Active status-> input sees a 680 ohm resistor

Technical specification

Outputs

1. Extinguisher released -> output high 26v
2. FRE operated
3. FPE disabled
4. FRE disabled
5. Panel in fire, will remain on after panel soft reset for > 15 minutes, or extinguish immediately with interface reset
6. Disable all sounders

Optional Functions not approved to EN54 P2&4

Italian mode: (Option not required by EN54 pt2)

This mode can be programmed at access level 3. This relates to points 12.2(a) & 12.2(b) of the Internal Italian Ministerial Decree 9th April 1994 which states that in the event of a fire detection from 2 or more detectors or from an MCP there should be a 2 minute delay before output activation otherwise in the event of a fire detection from any one detector there should be a 5 minute delay before output activation, provided that the fire event is not acknowledged. These delays apply to siren activation as well as the shutting down/activation of other external equipment and additionally the legislation states that these delays should be adjustable depending on the type of activity being carried out within the building.

For example, if there was a fire detected from a single detector then we should start a 5-minute (adjustable) delay (T2). If however a fire is detected from a second detector or a call-point the delay should automatically revert to 2 minutes (adjustable) (T1). In this scenario the value of (T1) is critical. To keep things simple, let's assume that we set T1 = 2 minutes & T2 = 5 minutes.

Day/night (Option not required by EN54 pt2)

This mode can be programmed at access level 3. An interface needs to be programmed in day/night. When this interface is set to off, the panel is in Day mode. In the event of fire, the detectors respond in heat mode, not smoke mode.

When the panel is in Night mode (interface is set to on), the delay is set to zero.

Swedish mode (Option not required by EN54 pt2)

This mode is programmed at access level 3. One of the Swedish requirements is that access level 2 & 3 is only available by the access of the keyswitch. The key switch is wired to the class change input.

Commission per loop (Option not required by EN54 pt2)

This mode is programmed at access level 3. This allows the commissioning engineer to auto learn one loop at the time

Alarm verification (Option not required by EN54 pt2)

This mode is programmed at access level 3. This has the flexibility to delay the activation of detectors by 30 seconds.

In the event of an alarm from a detector, the led of the detector will be illuminated and no alarm will be displayed on the panel. The detectors are checked continuously for 30 seconds. If after this time, the detector is still in alarm, the output will be activated otherwise the detector will be reset.

Timer T1/T2 (Option not required by EN54 pt2)

This mode is set on at access level 3 and is a commonly used by Eastern European Countries.

In the event of a Fire the timer T1 can be set from 1 to 3 mins where the alarm will be displayed on the panel and no output activation, if during this time the alarm is acknowledged then timer T2 can be set from 1-10 mins where the alarm can be investigated and alarm reset.

However if timer T1 & T2 time out during alarm activation, the outputs will be activated.

Timer T1/T2 with Call point Override (Option not required by EN54 pt2)

This is similar to the above except a call point alarm will activate the output instantly.

Cable & wiring

Cable & wiring

Only the cable types listed below are allowable for loop connections.

- Enhanced Fire TUF
- Fire TUF™
- FP200
- MICC

When choosing your preferred cable type, you must take note of the following cable and wiring requirements.

1. The cable must be 2 core screened with an over sheath
2. Maximum loop length with any of the above cables is 2KM
3. Maximum volt drop must be limited to 7 volts
4. The conductors should be 1mm minimum and no larger than 1.5mm
5. Multicore cable should not be used for Sensor wiring
6. Different loops should NEVER be run within the same cable
7. Loop feeds and returns should NEVER be used within the same cable

Cable resistance

Core diameter	Typical FP200 resistance
1.0mm ²	18.1 Ohms/km/Core
1.5mm ²	12.1 Ohms/km/Core
2.5mm ²	7.41 Ohms/km/Core
4.0mm ²	4.61 Ohms/km/Core

Cable anchorage

The mains cable must be fixed securely with a 20mm cable gland. Remove a suitably located knockout feed the cable through the gland and bolt the gland to the backbox as shown. Secure the cable to the side of the box using the cable clip provided.

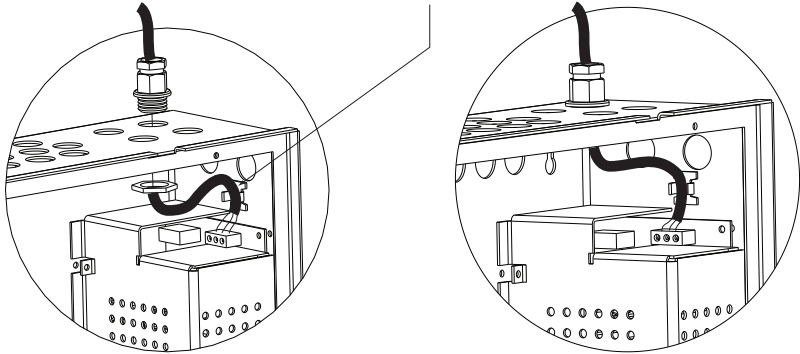

Note: The mains cable tail ends must be insulated to prevent dangerous conditions arising in the event of accidental switching on of the mains supply.

Installation

Installation

The panel should be installed in a clean, dry, reasonably well ventilated place, and not in direct sunlight. Temperatures in excess of 40°C and below 5°C should be avoided, if in doubt consult Eaton Service. The panel should be located away from any potential hazard, in a position where it is readily accessible to authorised staff, and the fire services, ideally on the perimeter of a building near a permanent entrance. Mount the panel to the wall using dimensions provided on page 45. Do not drill through the panel to the wall as dust will contaminate the circuitry.

Installation guide

- I. Never carry out insulation tests on cables connected to electronic equipment
- II. **DO NOT OVERTIGHTEN TERMINAL CONNECTOR SCREWS**
- III. Always use the correct type of cables specifically designed for the operation of fire detection and alarm circuits
- IV. Always adhere to volt drop limitation when sizing cables
- V. Always observe polarity throughout.
Non colour coded conductors should be permanently identified
- VI. Screen continuity must be maintained throughout the entire loop circuit including at each junction point and at each device, terminals are provided on each device to facilitate this
- VII. The screen should be earthed at the connection point provided at the panel and not at any other point. Both the loop start and the loop end must be connected to the appropriate earthing points. Care must be taken to avoid connecting the screen to the earthed body of any metal devices, enclosures, cable containment or building earth. The screen or drain wire of the loop cables should not be considered as safety earth and therefore should not be connected to terminals marked with the earth symbol, except at the panel, and should not be insulated with green and yellow sleeving
- VIII. The panel utilises intelligent soft addressing technology to greatly simplify the installation and commissioning processes. Once the system has been installed and the autolearn menu selected, the control panel will automatically scan the detection loops and allocate each device with an address number corresponding with its position on the loop, this avoids the traditional need for manual addressing of the system devices which is time consuming and provides a potential for error
- IX. It is of vital importance that accurate details are kept of the exact wiring route in order to determine which address has been allocated to each device

Fixing details

Read all the installation instructions before commencing with the installation. The installation of this panel must be carried out by a suitably qualified /trained person. The installation must comply with IEE wiring regulations and with BS5839 part 1 2002.

The electronic components within the fire panel are Static Sensitive. Do not touch the electronics directly.

Mounting the backbox

The panel can be flush mount or surface mounted.

1. Surface Mount; drill four holes and fix the backbox to the wall
2. Flush mounting the backbox requires a hole 364x 472 with a depth of 117mm (standard battery / backbox) or 217 mm if deep backbox is used

Installing Cabling

Once the backbox is mounted the next stage is to install the power and loop cables and fit the glands.

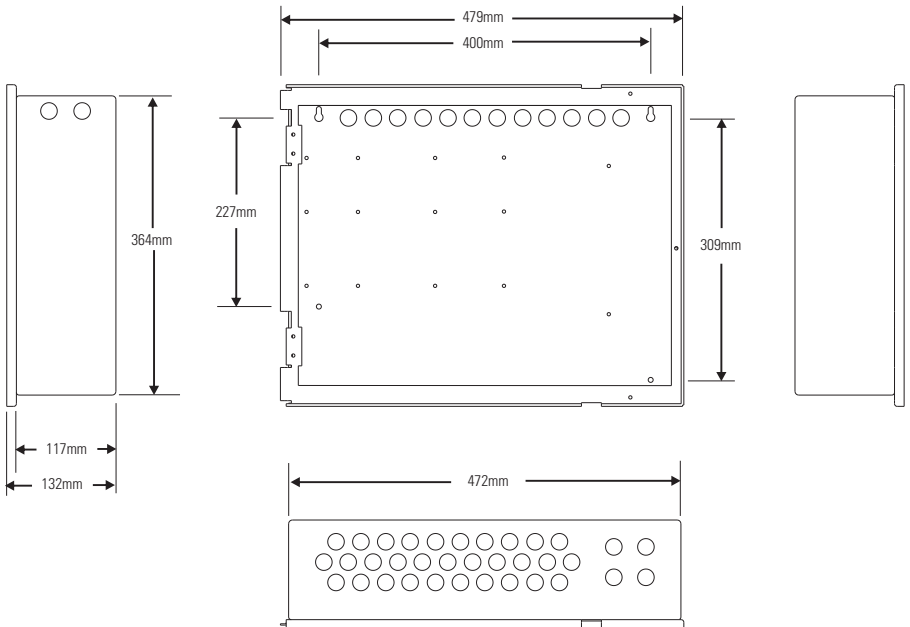

Installation

External connections (Mains supply)

The mains supply should be installed in accordance with the current edition of the IEE wiring regulations. Connection to the mains supply must be via an isolating device (e.g. an isolating fuse rated at 3Amps maximum) reserved solely for the fire alarm system. The cover should be coloured red and labelled "FIRE ALARM - DO NOT SWITCH OFF". The isolating protective device should be secure from unauthorised operation and ideally installed in a securely closed box with a breakable cover.

An additional warning label should be provided, depending on whether:-

1. The isolating protective device is fed from the live side of the main isolating device in which case the label on the isolating protective device, should read in addition

 **WARNING**

THIS SUPPLY REMAINS ALIVE WHEN THE MAIN SWITCH IS TURNED OFF.

A further label should be placed on the main isolating device reading

 **WARNING**

THE FIRE ALARM SUPPLY REMAINS LIVE WHEN THIS SWITCH IS TURNED OFF.

Or

2. If the isolating protective device is fed from the dead side of the main isolating device, a label should be fixed to the main isolating device reading

 **WARNING**

THIS SWITCH ALSO CONTROLS THE SUPPLY TO THE FIRE ALARM SYSTEM.

Distributed power supplies

The above also applies to any distributed power supply (i.e. mains connections for control panels, repeater units and relay units etc.)

Cable segregation

All cables for the fire alarm system should be segregated from any other cables/wiring/services.

Wiring configurations

Spurs can be taken off the loop in the following ways:

1. CZMU352 Addressable Interface - Allows up to 20 conventional smoke detectors and unlimited Eaton conventional call points

2. Direct Loop Spur Wiring - Allows a zone of analogue sensors and callpoints to be directly spurred off the loop

Note: The mains cable tail ends must be insulated to prevent dangerous conditions arising in the event of accidental switching on of the mains supply.

Networking

Up to 126 panels, or passive repeaters can be networked together to operate as a single networked system. To achieve this each panel must be fitted with a network card (supplied at additional cost.)

When operating as a networked system all fire and fault event information is displayed at every panel, silencing and resetting of alarms can also be carried out from any panel on a networked system if panels are suitably configured.

Networked panels are connected using a loop topology as illustrated, or radial if using a network booster.

Networked panels can be used as active repeaters, alternatively a low cost passive repeater is available.

This can either be connected to a loop of an individual panel or it can be connected to the network, via a network card.

The recommended network cable for the network connection between panels is an enhanced Firetuf cable Manufactured by Draka cables (part number 910234.) Screen continuity must be maintained throughout the entire network circuit including at each junction point. The cable should be grounded at least once per segment, and preferably at each device. Grounding the shield at every device assists in suppressing 50/60 Hz standing waves. The screen or drain wire of the network cable should not be considered as a safety earth and therefore should not be connected to terminals marked with the earth symbol, except at the panel, and should not be insulated with green and yellow sleeving Where the network cable passes between buildings, screen continuity should not be maintained from building to building. A booster device must however be used irrespective of cable length and should be fitted at a suitable point in the link between buildings. The cable screen should be connected to the earth of one panel in each building.

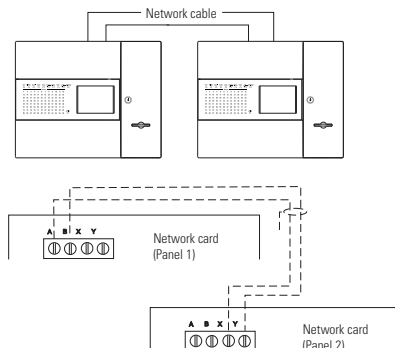

Installation

Input/outputs

Panel inputs

Class change: (OPTION NOT REQUIRED BY EN54)

A pair of terminals are provided for class change. By shorting these terminals together (e.g. Switch, Time clock) the alarm will sound (Panel sounders + loop sounders only). The Panel will not indicate a Fire. The alarm will cancel when the short circuit is removed. If the short circuit is not removed the alarms will not cancel.

Note: It is recommended that this input is wired using firetuf, fp200 or micc cable with the screen connected to the earthing points in the panel enclosure

WARNING

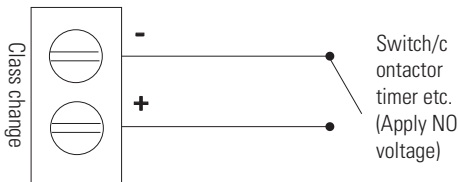

NO VOLTAGE SHOULD BE APPLIED TO THIS INPUT

Panel outputs

Panel sounders: (OPTION 7.8 EN54 PT 2)

Two pairs of outputs are provided. ONLY polarised equipment should be used. Ensure the polarity of the connections are observed at all times and end of line resistors (6K8 5%) are fitted for correct operation. The total alarm load across all sounder outputs = 1.5 Amp. All outputs are fused with 1.6 Amp Glass fuse Alarm devices should be spread equally across the 4 sounder circuits.

WARNING

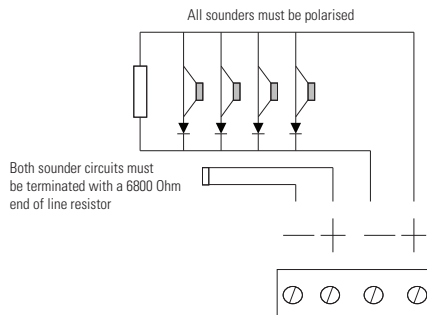

DO NOT EXCEED THE RATED OUTPUT CURRENT

Output fire alarm routing equipment

(Option 7.9 EN54 PT 2)

This output, which is fused and monitored using a 6.8k end of line resistor, is used for the automatic transmission of the fire signals to fire alarm routing equipment (e.g. Fire brigade). It operates by providing 12 Volt output to an auxiliary device (e.g. relay). It is current limited to 30 mA using a resettable polyswitch.

Class change and test conditions do not operate this output. If operated under a fire alarm condition, the indication will be displayed on the Touch screen display and will remain until the fire alarm is reset.

Ensure the polarity of the connections are observed at all times and end of line resistors (6K8 5%) are fitted for correct operation.

Output to fault warning routing equipment

(Option 9.4.1C EN54 PT 2)

This output, which is fused and monitored using 6.8k end of line resistor is used for the transmission of fault signals to fault warning routing equipment This output is monitored using 6k8 end of line resistor and it current limited to 30 mA.

Under normal conditions it operates by providing 24vdc which can be connected directly to a 24v auxiliary device(relay).It is current limited to 30 mA.

Under fault conditions or even if the panel is switched off, this output will switch to 0 volts. Ensure the polarity of the connections is observed at all times and end of line resistors (6K8 5%) are fitted for correct operation.

Auxiliary relay

(Option not required by EN54)

This output is a volt free contact, which is protected by a polyswitch. It is rated at 24 Volts 1Amp. If operated under a fire alarm condition , this output will remain energised until the fire alarm is reset

Auxiliary DC output

(Option not defined by EN54)

A 24 Vdc output is provided. This output is protected by a polyswitch. This output can be used to power fire or fault auxiliary equipment. Please ensure that all equipments connected to this output will only draw current when a fire condition exists.



DO NOT EXCEED THE RATED OUTPUT CURRENT

Maintenance

Maintenance

Functions: See User Manual for full details.

Daily inspection

Check that only the green "POWER ON" indicator shows. Inspect for any fault indication. Notify any faults to a system supervisor.

Weekly test

Check indicators.

Press Supervisor mode on the top left of the touch screen. Enter passcode. Select "others" tab. Press the button labeled weekly test, confirm you wish to perform the test and the amber "System Test" LED will light. The panel will stay in weekly test mode until the system is manually reset. During the weekly test, trigger a smoke Sensor or call point and check the fire panel registers the device and illuminates the correct zonal indicator. Trigger a different device every time a weekly test is performed ensuring devices are tested in rotation until all have been checked. It is advisable to develop a detailed building plan highlighting devices and locations to aid testing. Record weekly test in the table provided in this log book.

Quarterly

Check all previous log book entries and verify that remedial action has been taken. Carry out the weekly test. Visually examine the batteries and their connections, by loosening the screws behind printer door and opening the hinged front from the right hand side.

Disconnect the mains supply and check that the battery is capable of supplying the alarm sounders, by operating a call point.

Annual test

As Weekly Test and Quarterly Test above. Additionally test all sensors and call points and check operation.

Every 2-3 years

During the normal servicing cycle check analogue levels of the detectors. If any are approaching the pre-alarm level then the proprietary cleaning methods can be adopted. e.g. high pressure air spray.

Every 5 years

Replace sealed lead acid battery.

Servicing

Eaton Service can offer a regular servicing contract. Further copies of this log book are obtainable from:-

Eaton Electrical Systems Ltd.

Wheatley Hall Road

Doncaster

United Kingdom

DN2 4NB

Tel: +44 (0) 1302 303303

Fax: +44 (0) 1302 367155

Cleaning

When cleaning the panel, use a moist cloth. Do not use solvents or harsh abrasives.

Printer paper order code: ADF6PRINTERPAPER

Panel assembly information

Panel assembly information

Attaching the door

The door is designed as a drop on fit. Offer the door up to the back box in the open position as shown below. Align the hinges and lower the door onto the hinge pins. Check the hinges are secure.

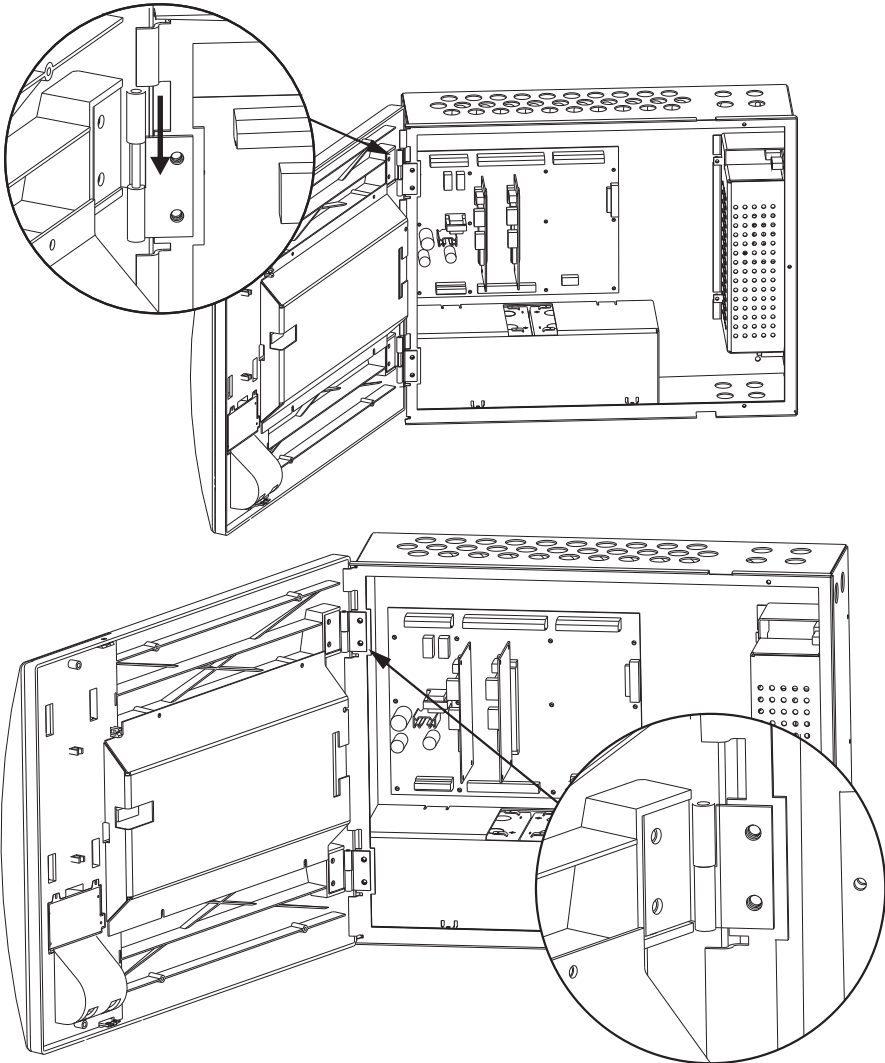

Installing a hinged cover

This can be fitted as standard equipment prior to despatch or retro-fitted later. The method for fitting a cover is shown below.

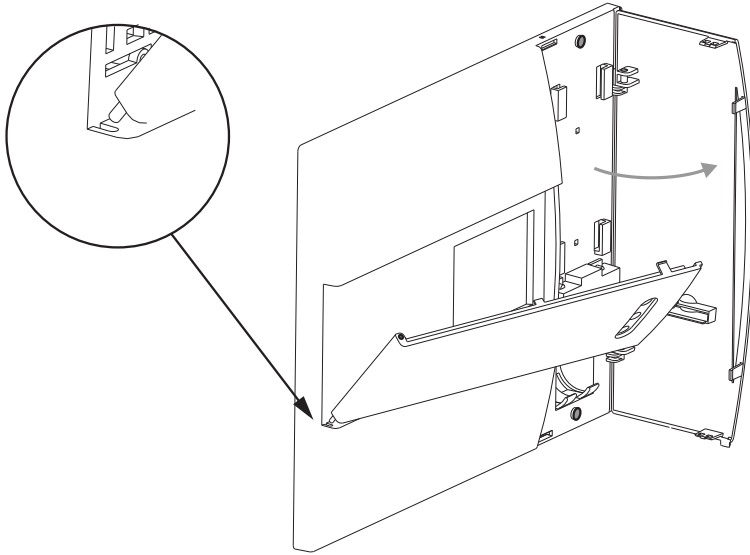

Insert the bottom peg of the hinged cover into the panel as shown and close the hinged cover followed by the printer door. Next from the back of the panel insert second peg through the hole shown below and push into the hinged cover.

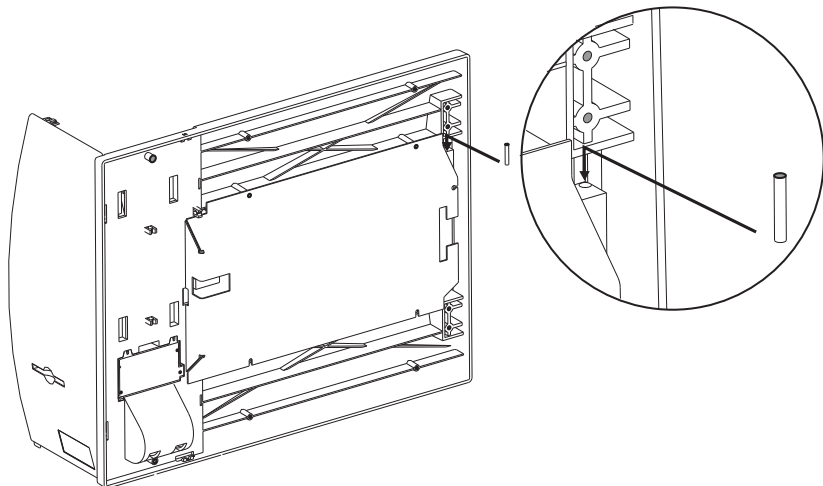

Panel assembly information

Fitting printer paper roll

Open the printer access door on the right hand side of the panel using the key provided. Drop the paper roll into the paper holder and feed paper into the printer. The printer will then automatically pull the paper through if the panel is powered up. Tear off the excess paper then close and secure the printer access door.

Please note for paper feed to operate correctly, paper end must be straight.

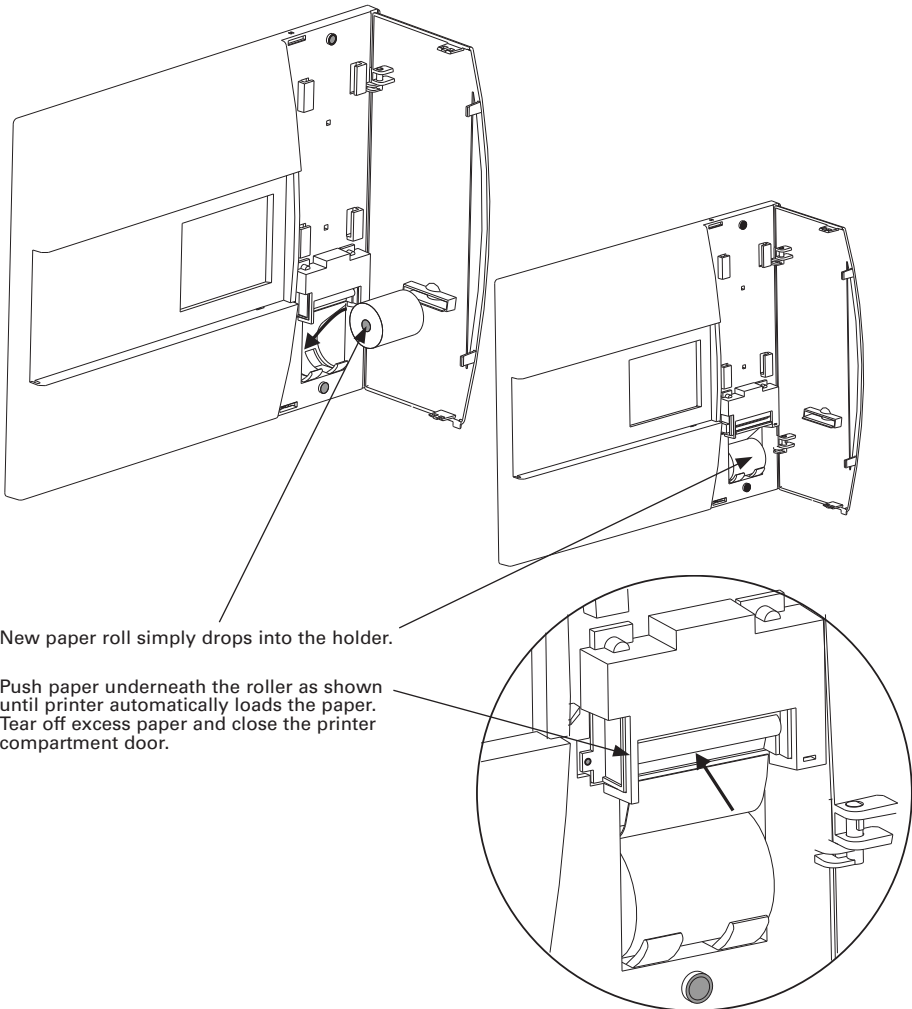

New paper roll simply drops into the holder.

Push paper underneath the roller as shown until printer automatically loads the paper. Tear off excess paper and close the printer compartment door.

Commissioning the Control Panel System

Commissioning mode

Walk test mode allows a single engineer to test the various sensors and call points on a system without always having to return to the panel either to reset the system or silence the alarms. When in COMMISSIONING MODE, the system operates as normal except that when a Sensor or call point goes into alarm, the alarms only operate for a few seconds and then will silence. After a full test has been carried out the engineer can check the order in which the sensors/call points were operated using the DISPLAY LOG mode. This information can also be printed on the optional printer.

When the panel is in "Walk Test Mode" the control panel inserts a different code into the log and also onto the print-out. This is to distinguish between when a device has been tested in "Walk Test Mode" and when a device has been triggered while in normal operation.

The following differences will occur:

- I. When in the LOG mode, "One man walk test"" will appear on the display followed by the address text and device type
- II. On the printout a "One man walk test" message will appear will appear followed by the address text and device type
- III. During a real fire "FIRE !" Will appear on the display followed by the address text and device type

Configuration

DB level check

The panel includes the facility to test and set the system sounders with the minimum amount of disturbance. In sounder test mode, the sounders will sound for 30 seconds on then 30 seconds off. This facility can be accessed via the engineering menu.

Sensor LED flashing

The control panel Sensor flashing function is used to allow a visual inspection and confirmation that the fire panel is in communication with the installed system devices. This facility can be accessed via the engineering menu and can be switched on or off at any time as required.

Commissioning the Control Panel System

Up/downloading using PC software

The PC Software enables the address, location text, device type and any comments to be downloaded to the panels.

The software can download to all 126 networkable Panels.

The PC is connected to each Panel on the network in turn. All data for the Panel is downloaded.

For networked systems, panels are identified by panel number, P1, P2 etc.

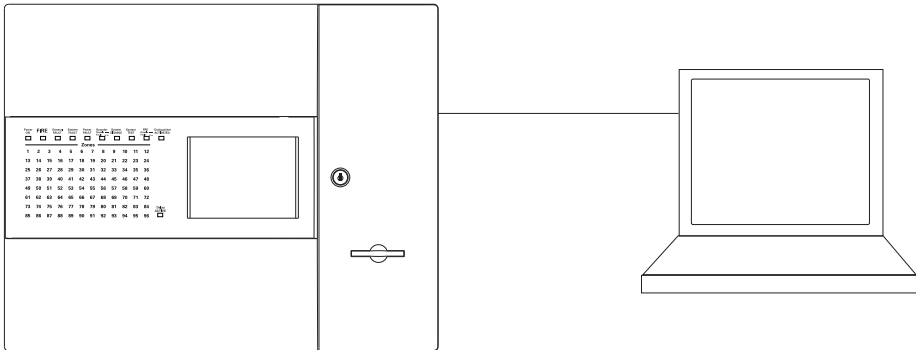

Panel fault finding

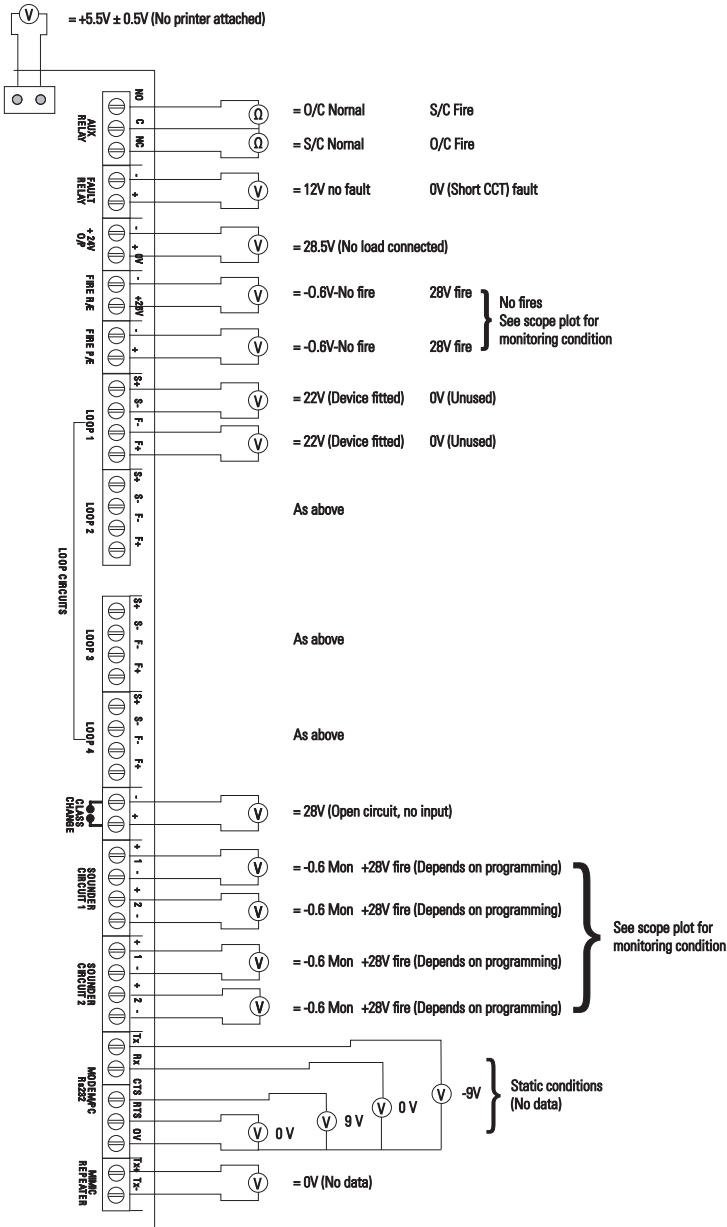

PC commissioning software

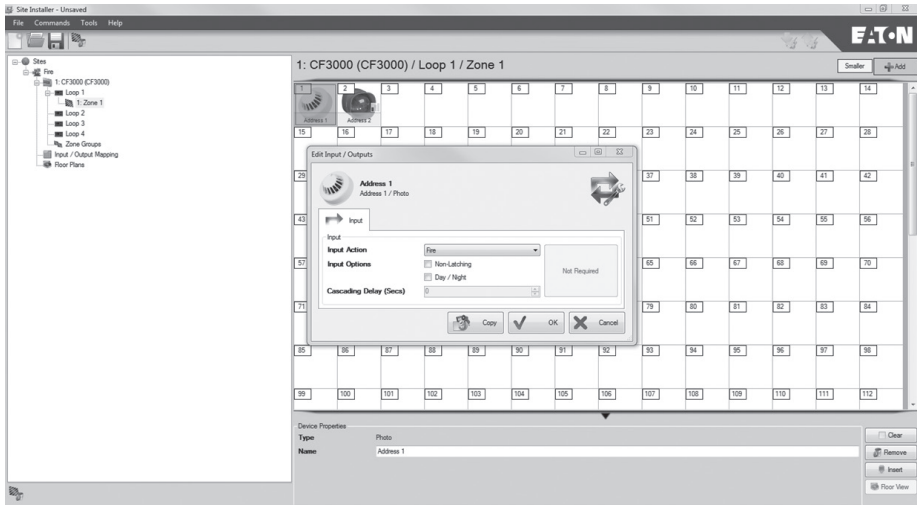

Device Inputs

Device input programming

- Fire = panel reports fire from device.
- Fault = panel reports fault from device.
- Reset = panel resets.
- Silence = silence all currently active sounders.
- Technical/Input = No indication on display, creates a log entry.
- Evacuate = Sends an evacuation command.
- Fire/Extinguisher Activate = German mode only.
- FRE Activate = German mode only.
- None Fire = No indication on display, creates a log entry.
- Cascade = Selects a delay in seconds on the device within the list This will go to alarm after the selected time so can be used as a further trigger source.
- Isolate Addresses = This allows a group of addresses (max 8 on the same loop) to be isolated from the trigger. Panel does not go to Fire, trigger is non-latching
- Isolate Zones = This allows a group of zones (max 8) to be isolated from the trigger. Panel does not go to Fire, trigger is non-latching

Non-Latching

Non-latch is a feature where the panel goes back into quiescent state when the Fire situation is cleared.

Day / Night

Devices affected:

- Optical-Heat – mode changes between heat or opto-heat mode.
- Heat – mode changes between Heat A1R and Head CS.

Cascading Delay

Set a delay duration when the cascade input action is selected.

Allocate Zones/Devices

User can define between zones or addresses to be isolated on activation of the device. The isolate list button enables the user to enter upto 8 unique zones or addresses.

PC commissioning software



Device Outputs

Sounder Trigger

The output device can be programmed to respond to a specific trigger – globally, by zone, by address or by panel.

Delay Configuration

The output of a device when triggered can be delayed – based on a user defined value in minutes.

This programming option is enabled when a value other than zero is entered inside the 'Delay' window.

MCP Override

This option is a manual intervention override. When enabled, the delay can be overridden from any call point on the loop when triggered.

Allocation List

If the sounder trigger is by address, zone or panel, then the trigger source can be selected from the Allocation List box. Panel outputs

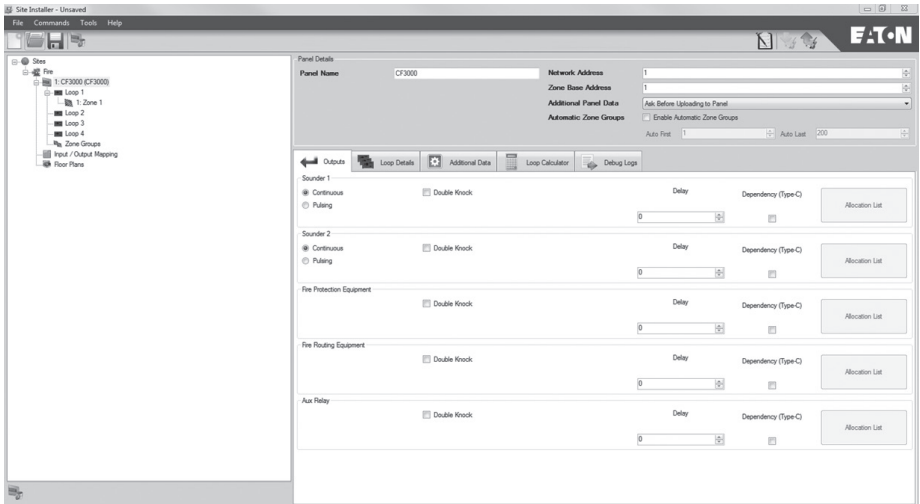

Panel Outputs

Dependency detection

Each panel output can be assigned a unique list of zones derived from the zones available on the loop, to activate this output, two unique zones from this list have to be in fire or alternatively any zone outside this list will trigger the output also. When the 'Dependency' box is checked - the 'Allocate device' button allows the user to populate this list.

Panel controls & indicators

Panel controls & indicators

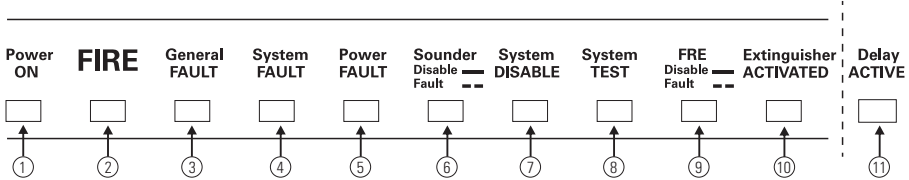
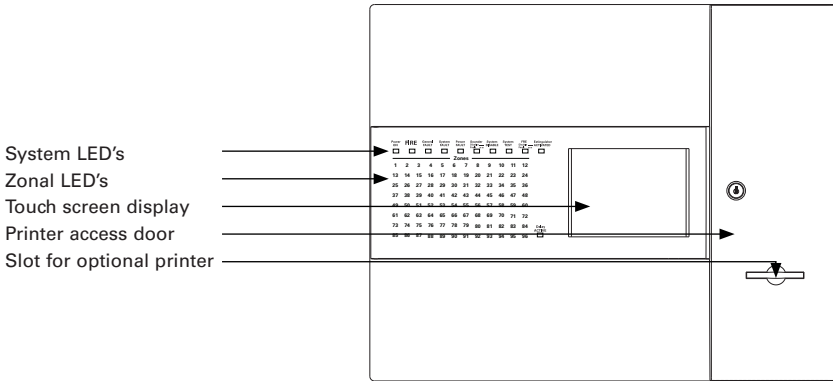

LED	Name	Function	Action
①	Power on	Shows panel is on	Check indicator is illuminated
②	Fire	Indicates panel has detected a fire	Implement fire action procedure
③	General fault	Monitors devices for faults e.g. Smoke detectors/sounders	Report to system supervisor
④	System fault	Monitors fire panel for faults	Report fault to service dept
⑤	Power fault	Monitors internal battery charger	Report fault to service dept
⑥	Sounder	Monitors sounder circuits	Report fault to service dept
⑦	System disable	Part of the system has been disabled	Report to system supervisor
⑧	System test	Supervisor/engineer is testing the system	Check with system supervisor
⑨	FRE	Monitors status of FRE output	Check with system supervisor
⑩	Extinguisher activated	Display activation of extinguishers (if option fitted)	Check with system supervisor
⑪	Delay active	Delays on outputs active	Check with system supervisor

Panel controls & indicators

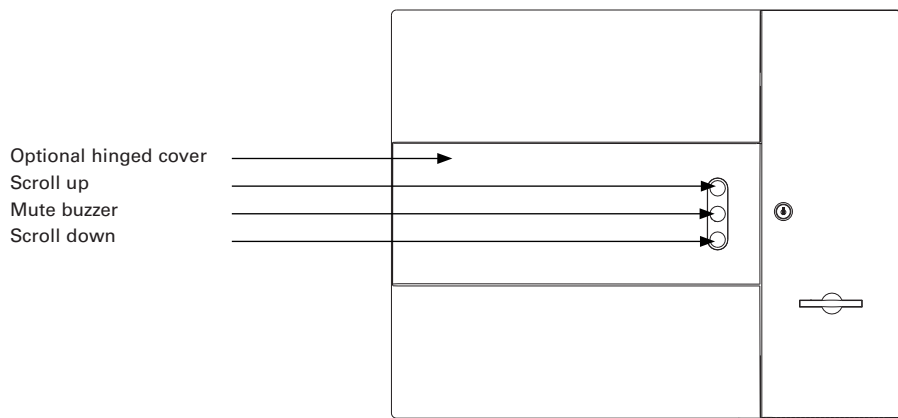
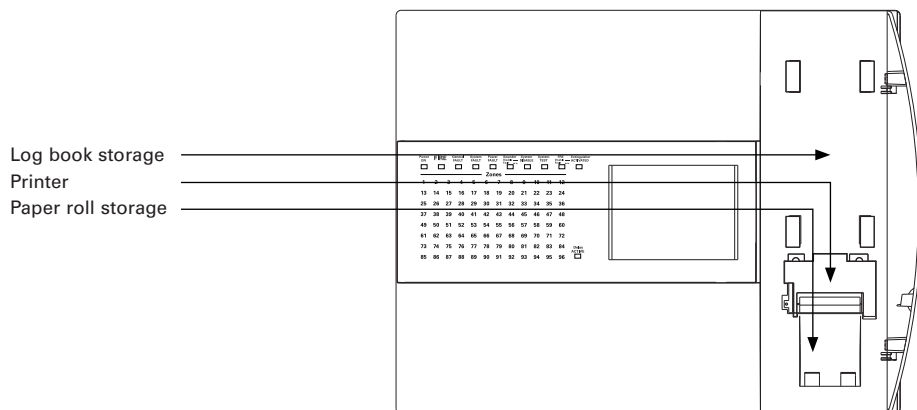

Panel controls & indicators

Touch screen display

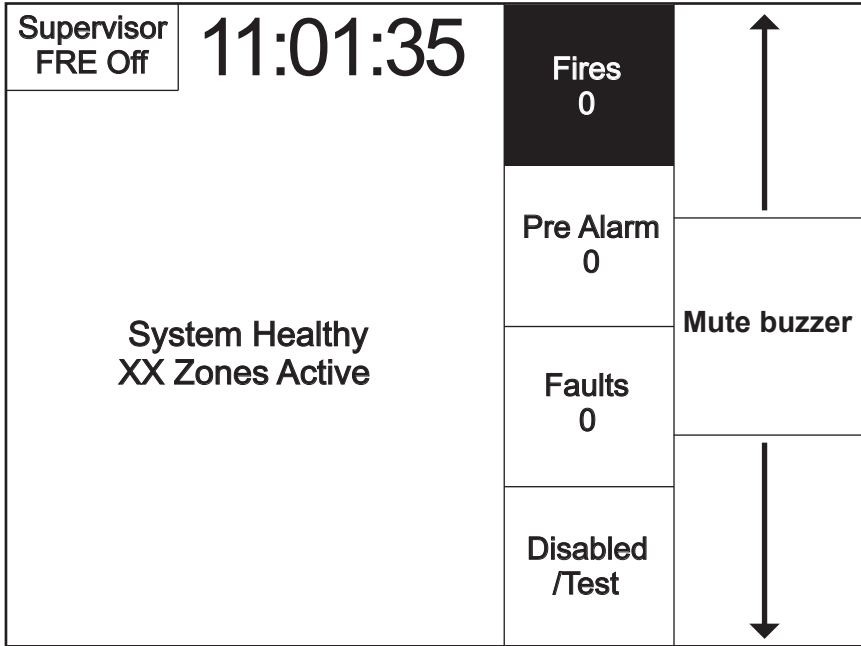

The Touch Screen is a multi-function display consisting 320x240 dots featuring high intensity backlighting. In normal operation, the display indicates as above with the backlighting off.

During an event on the system the display shows the FIRST EVENT and LAST EVENT plus other events as space allows.

The last 2 lines are normally used to display the total number of events, but they are also used for scrolling fire conditions, faults, pre alarms or disabled devices independently or for displaying a reduced menu when in fire condition.

When an event occurs the Touch Screen backlighting comes on unless there is a mains power supply fault.

Use the Touch Screen to scroll through all active events on the system by using the SCROLL UP and SCROLL DOWN buttons (available at access level 1). You can display the contents of the log and also view details of any fires, faults, pre-alarms, faults or disablements. When displaying the system menu on the touch screen, the last 5 lines of the display are shown in reverse text.

Panel operation

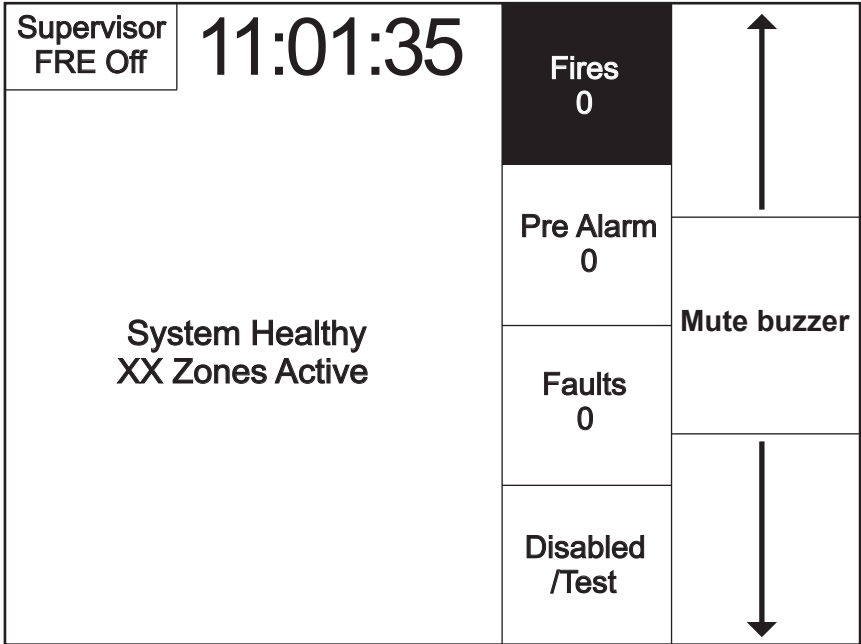

Pressing a field will highlight it and forward to the next screen as shown below.

Touch the screen here to view details

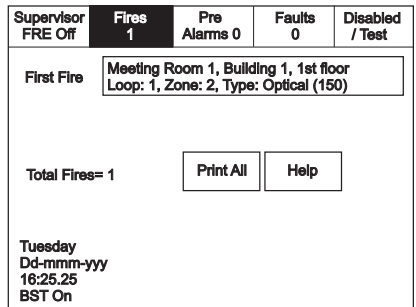
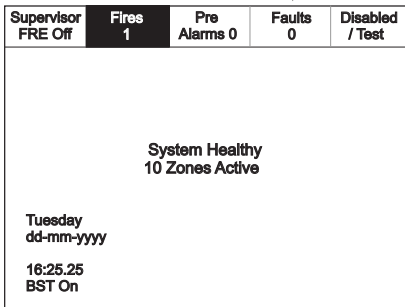

Panel controls & indicators

Public access level 1

Public access level does not require an access code and allows anybody to review the functions outlined below.

Public access level

Supervisor FRE off	Fires 0	Pre Alarms 0	Faults 5	Disabled / Test
System Healthy 10 Zones Active				
Tuesday dd-mm-yyyy 16:25.25 BST On				

Supervisor FRE off	Fires 1	Pre Alarms 0	Faults 0	Disabled / Test
First Fire	12:26:23 Device 1, Zone 1 Lp: 1, Ad:1, Z:1, Opto/thermal, [69]			
Total Fires= 1	<input type="button" value="Print All"/> <input type="button" value="Help"/>			
Tuesday dd-mm-yyyy 16:25.25 BST On				

Supervisor FRE off	Fires 0	Pre Alarms 6	Faults 0	Disabled / Test
<input type="button" value="Show Addresses"/> <input type="button" value="Show Zones"/> <input type="button" value="Show I/O"/> <input type="button" value="Show Test Zone"/>				
<input type="button" value="Print All"/> <input type="button" value="Help"/>	↑			
001 Device 2, Zone 1 Loop 1, Zone: 1, Type : Opto/thermal				
002 Device 3, Zone 1 Loop 1, Zone: 1, Type : Opto/thermal				
003 Device 4, Zone 1 Loop 1, Zone: 1, Type : Opto/thermal				
004 Device 5, Zone 1 Loop 1, Zone: 1, Type : Opto/thermal	↓			

Supervisor FRE off	Fires 0	Pre Alarms 6	Faults 0	Disabled / Test
<input type="button" value="Print All"/> <input type="button" value="Help"/>				
001 03-Jun-03 12:51 Warning! : Device1 Lp: 1, Ad: 1, Z: 1, Opto/thermal [69]	↑			
002 03-Jun-03 12:51 Warning! : Device2 Lp: 1, Ad: 2, Z: 1, Opto/thermal [69]				
003 03-Jun-03 12:51 Warning! : Device3 Lp: 1, Ad: 3, Z: 1, Opto/thermal [69]				
004 03-Jun-03 12:51 Warning! : Device4 Lp: 1, Ad: 4, Z: 1, Opto/thermal [69]				
005 03-Jun-03 12:51 Warning! : Device5 Lp: 1, Ad: 5, Z: 1, Opto/thermal [69]	↓			

Supervisor FRE off	Fires 0	Pre Alarms 6	Faults 5	Disabled / Test
<input type="button" value="Print All"/> <input type="button" value="Help"/>				
001 12:31:59 Fault! : Device1 Lp: 1, Ad: 1, Z: 1, Opto/thermal [0]	↑			
002 12:32:59 Fault! : Device2 Lp: 1, Ad: 2, Z: 1, Opto/thermal [69]				
003 12:33:59 Fault! : Device3 Lp: 1, Ad: 3, Z: 1, Opto/thermal [69]				
004 12:34:59 Fault! : Device4 Lp: 1, Ad: 4, Z: 1, Opto/thermal [69]				
005 12:35:59 Fault! : Device5 Lp: 1, Ad: 4, Z: 1, Opto/thermal [69]	↓			

Evacuate (Access level 2)

To activate the touch screen, touch the top left corner of the screen until the screen illuminates. To enter the supervisor mode touch the supervisor button and enter the passcode.

1. Enter the Supervisor Mode Passcode and select “Evacuate” on the menu at the top of the screen.
2. Select “Yes” to evacuate the building.

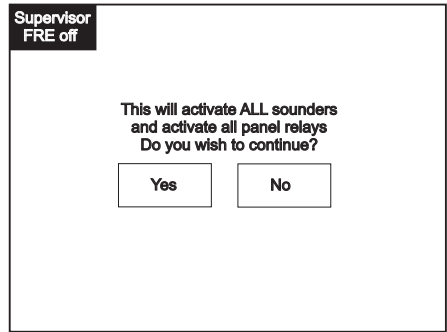
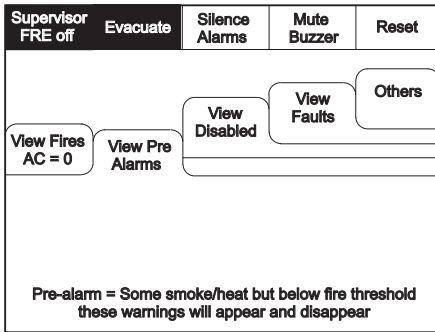

Silence alarms

To activate the touch screen, touch the top left corner of the screen until the screen illuminates. To enter the supervisor mode touch the supervisor button and enter the passcode.

1. Enter the Supervisor Mode Passcode and select “Silence Alarms” button as the top of the screen.
2. Select “Yes” to evacuate the building.

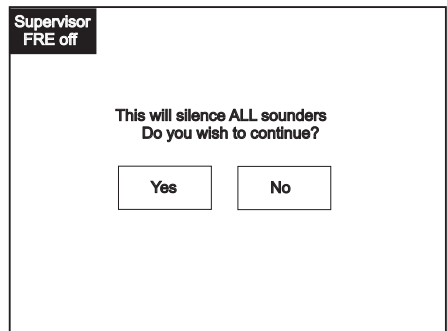
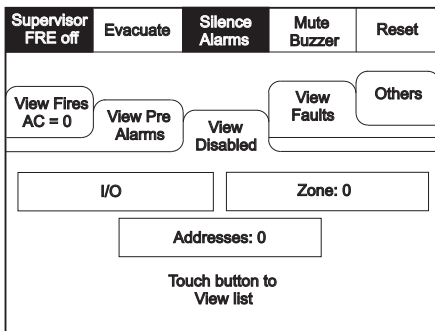

Panel controls & indicators

Mute buzzer

To activate the touch screen, touch the top left corner of the screen until the screen illuminates. To enter the supervisor mode touch the supervisor button and enter the passcode.

Enter the Supervisor Mode and Select "Mute Buzzer" from the Top Menu.

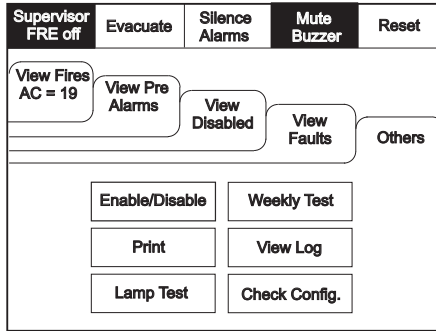

Reset

Enter the Supervisor Mode and Select "Reset" from the top Menu. Select "Yes" to reset the panel.

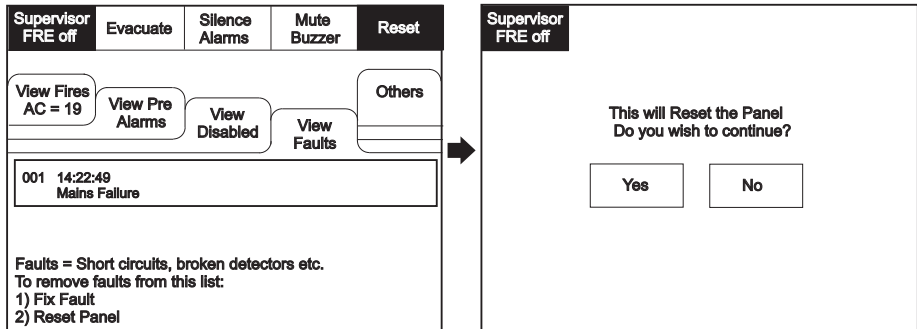

Pre-alarms

Enter the Supervisor Mode and Select “Pre-Alarms” tab.

A pre-alarm is shown when a detector appears to register heat or smoke but in a quantity that is insufficient to warrant an alarm.

Pre-alarm may indicate a build up of dirt in a smoke detector which can be interpreted by the detector as smoke presence.

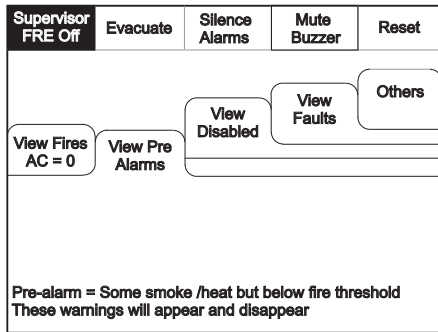

Faults

Enter Supervisor Mode Passcode and select “Faults” tab.

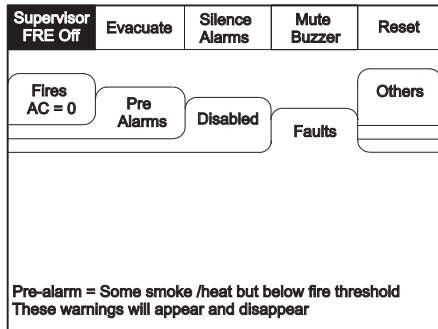

Panel controls & indicators

Disabled devices

Enter the Supervisor mode and Select the "Disabled" tab.

The individual buttons show which devices and the number of devices which have been disabled. Press one of the buttons to display detailed information for a particular category

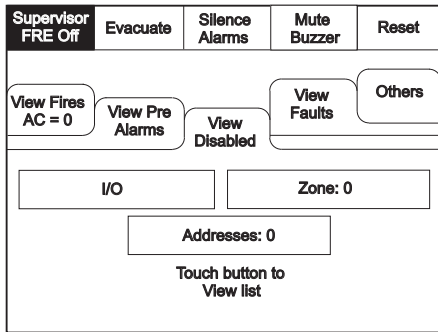

Enable/disable (Others menu)

To activate the touch screen, touch the top left corner of the screen until the screen illuminates. To enter the supervisor mode touch the supervisor button and enter the passcode.

Enter the Supervisor Mode passcode and select the "Others" tab.

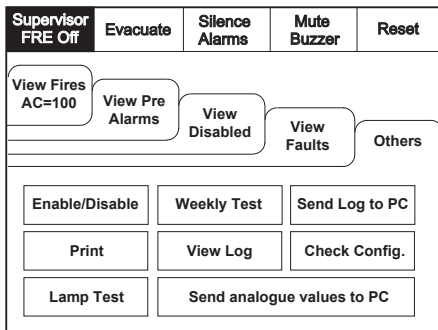

Panel controls & indicators

The Enable/Disable feature allows the operator to disable part or a whole system by the sub menus shown on the left.

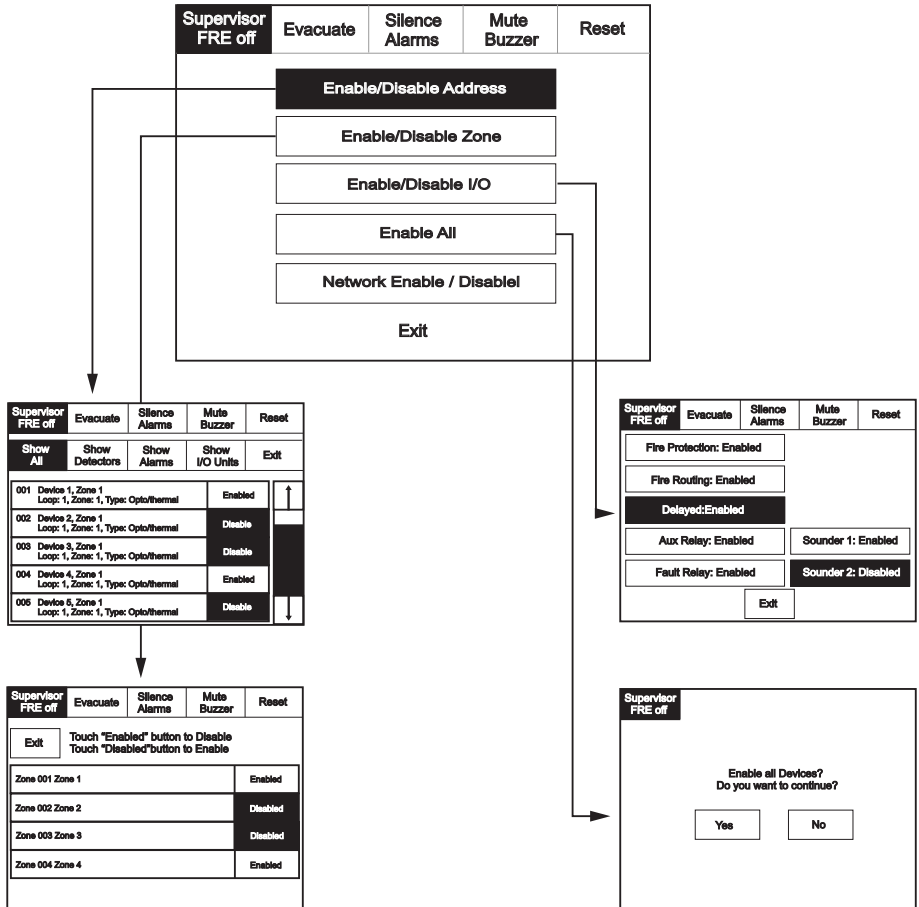

Panel controls & indicators

Print

To activate the touch screen, touch the top left corner of the screen until the screen illuminates. To enter the supervisor mode touch the supervisor button and enter the passcode.

1. Enter the Supervisor Mode and Select the "Others" Tab. Press "Print"
2. Select the Information You wish to Print from the Buttons Listed.

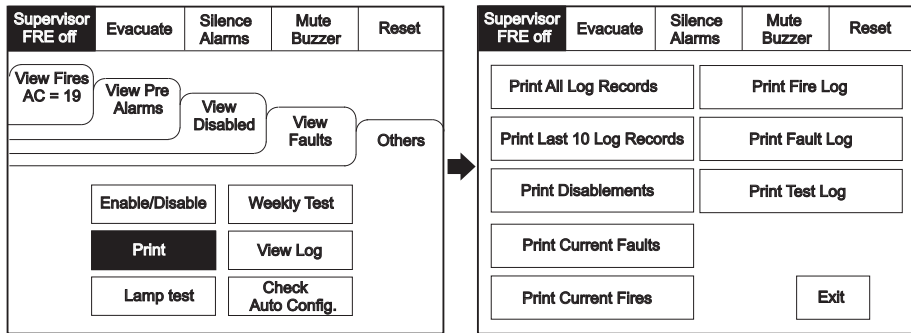

Lamp test

To activate the touch screen, touch the top left corner of the screen until the screen illuminates. To enter the supervisor mode touch the supervisor button and enter the passcode.

1. Enter the Supervisor Mode and Select the "Others" Tab. Press "Lamp Test"
2. Press "Lamp Test"

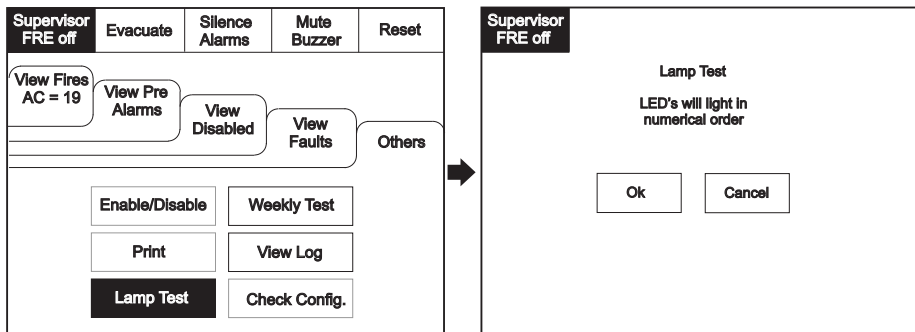

Weekly test

To activate the touch screen, touch the top left corner of the screen until the screen illuminates. To enter the supervisor mode touch the supervisor button and enter the passcode. Select the others tab as shown below. Press Weekly test.

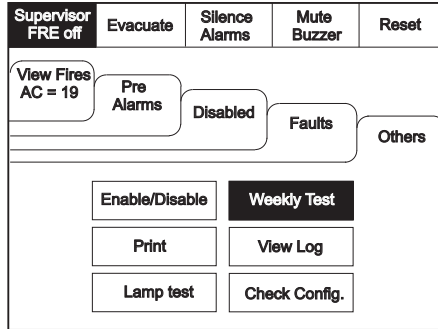

Weekly test is now in progress.

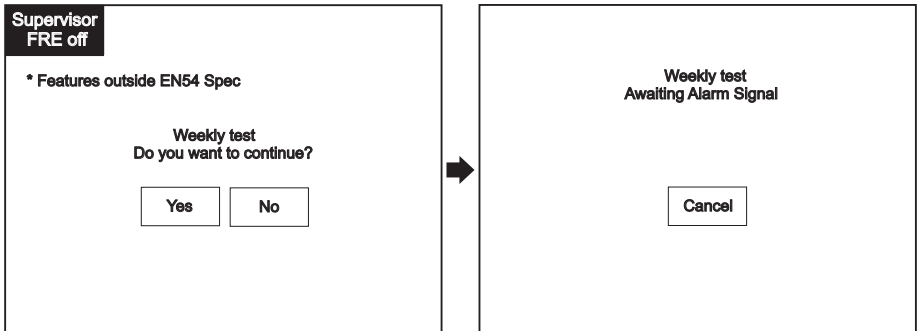

The weekly test will ask the user to carry out a reset on completion of the callpoint operation.

Panel controls & indicators

Viewing events

To activate the touch screen, touch the top left corner of the screen until the screen illuminates. To enter the supervisor mode touch the supervisor button and enter the passcode.

1. Enter the Supervisor Mode Passcode. Select the "Others" tab and press View Log.

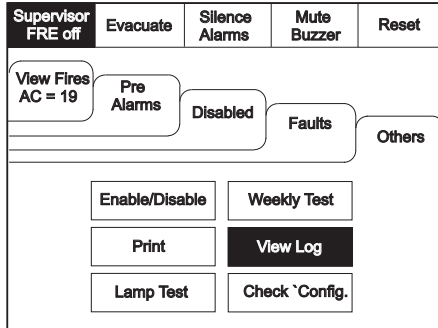

2. Use the scroll bar to view the list of upto 10,000 events.

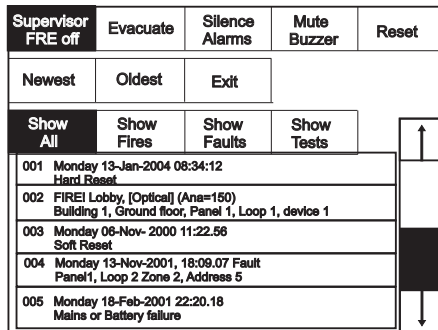

Note: Events can be sorted by selecting from the sort option menu.

The panel event log stores up to 10,000 events including, fires, faults, resets and address changes. Once the maximum 10,000 events has been reached, the panel will automatically overwrite the oldest event every time a new event is stored. The event log can only be reset by an approved service engineer.

Check auto config

To activate the touch screen, touch the top left corner of the screen until the screen illuminates. To enter the supervisor mode touch the supervisor button and enter the passcode.

Enter the Supervisor Mode and Select the "Others" Tab. Press Check Auto Config. This feature will scan the loop and pinpoint the exact location of any break in the loop wiring and will also identify any changes in the loop configuration (e.g. New devices added or changed device types).

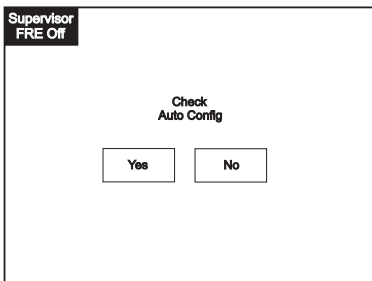
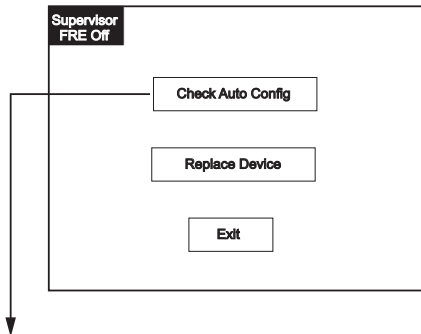
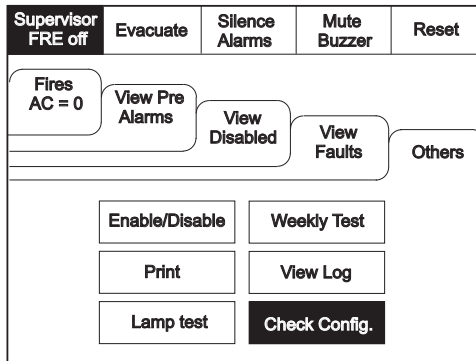

Press the supervisor mode button at the top left of the screen.

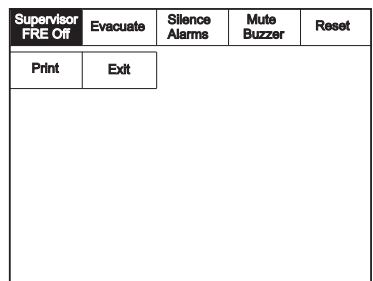

Panel controls & indicators

Replace device

Replace device enables an existing device to be replaced with a new device without losing the existing text and sounder programming.

Replace a single device then use the replace device menu to allocate an existing address to the new device

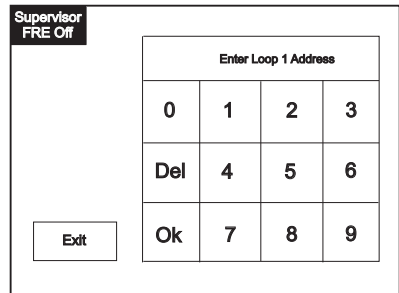
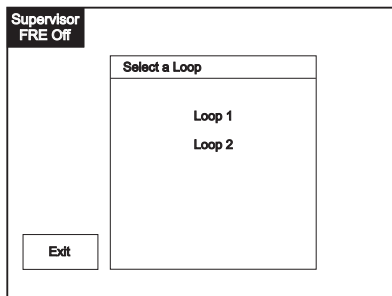
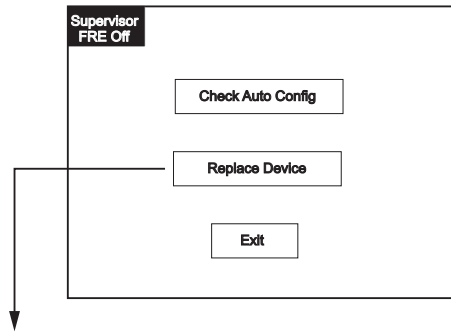
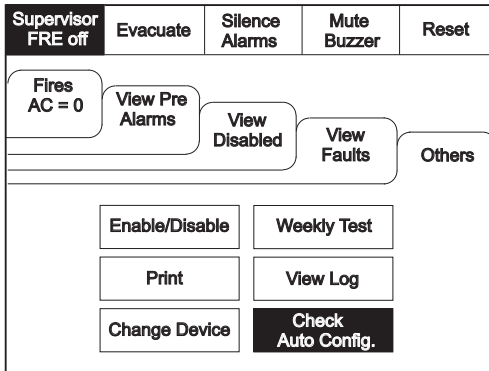

Test Device (Access Level 3)

To activate the touch screen, touch the top left corner of the screen until the screen illuminates. To enter the service mode touch the supervisor button and enter supervisor passcode.

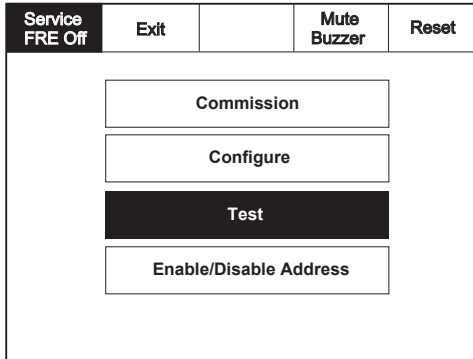

Enter the service mode. Select "Test"

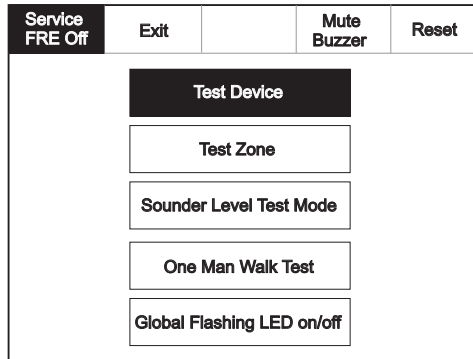

Select the "Test device" button.

Touch row to select device to test.

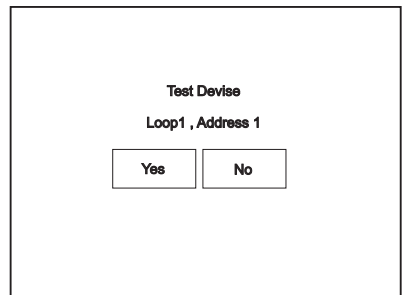
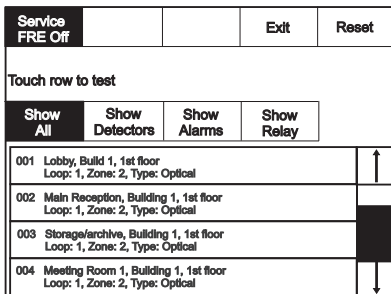

Panel controls & indicators

Test zone

To activate the touch screen, touch the top left corner of the screen until the screen illuminates. To enter the supervisor mode touch the supervisor button and enter the service passcode.

1. Enter the Service Mode, Select "Test" and on the Screen Shown Below
2. Press "Test Zone"

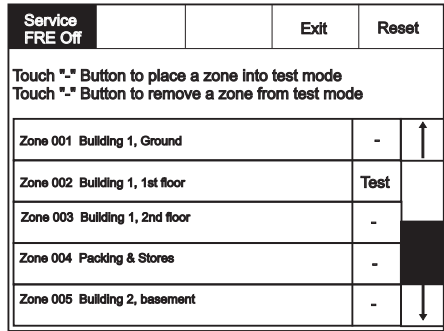
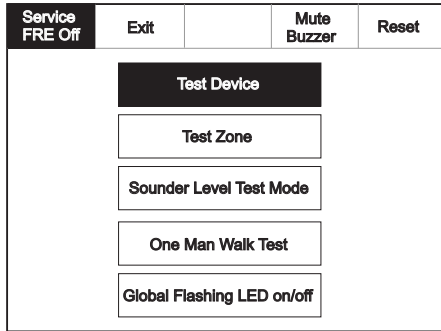

Sounder level test mode

1. Enter the Service Mode and Select Test.
2. From the Test Menu Select "Sounder Level Test Mode"

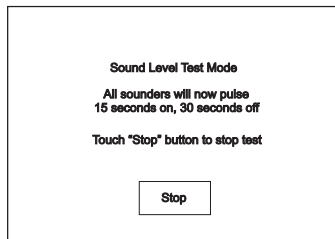
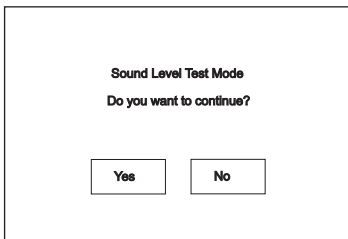
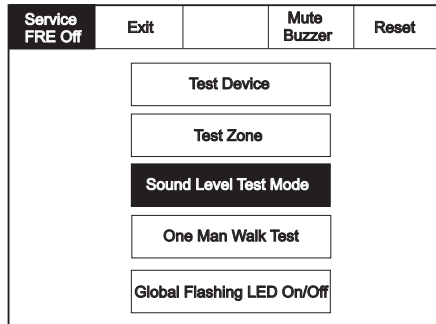
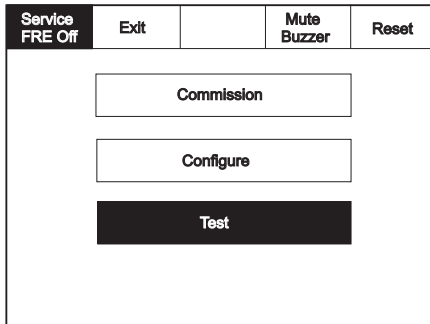

Global flashing LED On/Off

To activate the touch screen, touch the top left corner of the screen until the screen illuminates. To enter the supervisor mode touch the supervisor button and enter the service passcode.

Enter the Service Mode and Select Test.

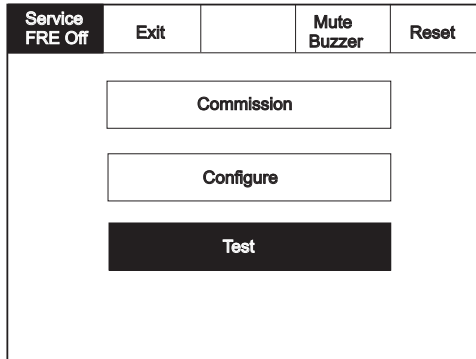

If global LED flashing is set to on, all device LED's will pulse intermittently to confirm correct communication.

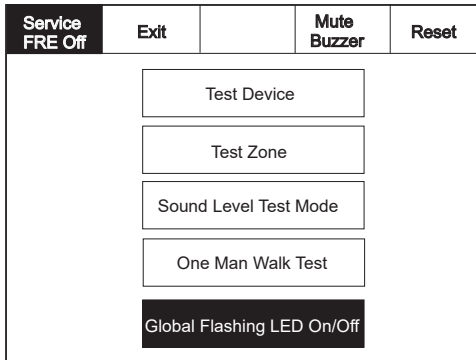

Select "Global flashing LED on/off from the test menu screen."

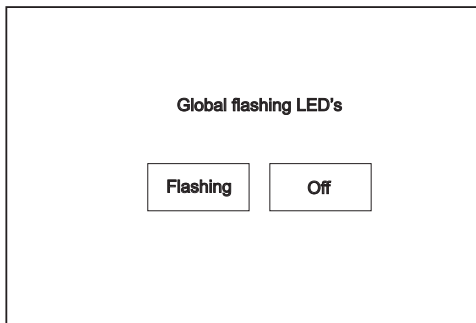

Panel controls & indicators

One man walk test

To activate the touch screen, touch the top left corner of the screen until the screen illuminates. To enter the supervisor mode touch the supervisor button and enter the service passcode.

Enter the Service Mode and Select Test.

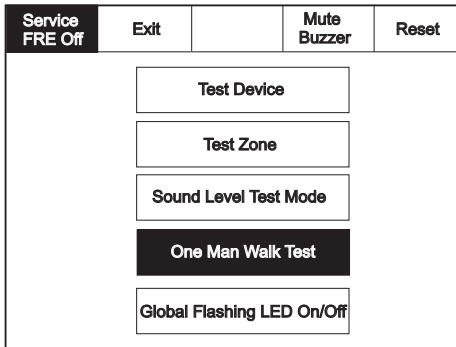
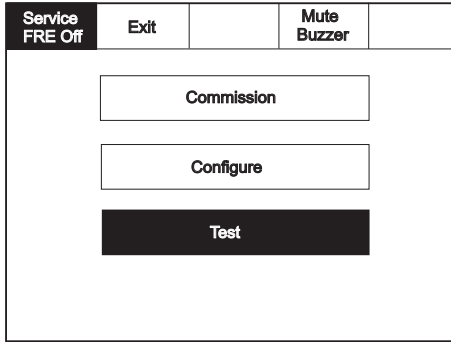

Select "One Man Walk Test" from the test menu screen

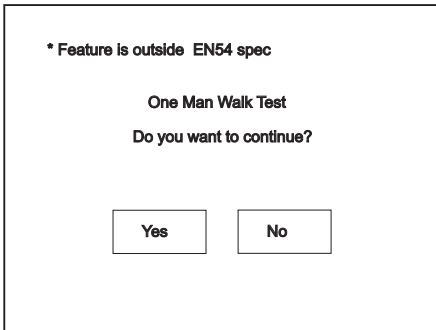

Commission

Load CDR from laptop

To activate the touch screen, touch the top left corner of the screen until the screen illuminates. To enter the supervisor mode touch the supervisor button and enter the service passcode.

Enter the Service Mode and Select Commission.

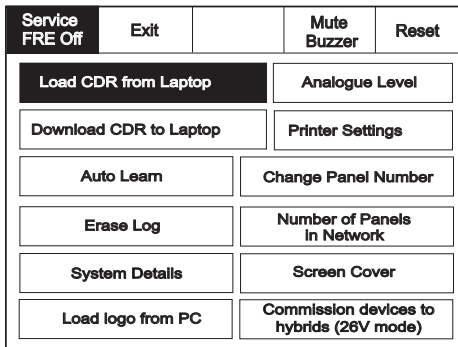
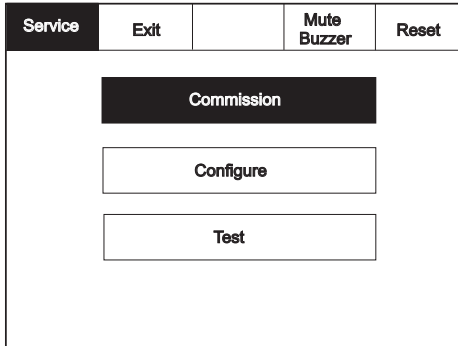

Select "Load CDR from Laptop" from the Commission Menu"

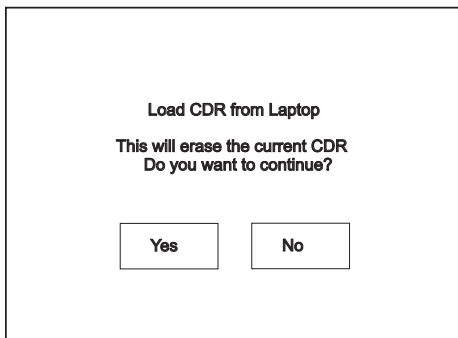

After pressing "Yes" click commission on the PC download software.

IMPORTANT:
Do not click commission before pressing "Yes" on the "Load CDR" screen.

Panel controls & indicators

Download CDR from laptop

To activate the touch screen, touch the top left corner of the screen until the screen illuminates. To enter the supervisor mode touch the supervisor button and enter the service passcode.

Enter the Service Mode and Select Commission.

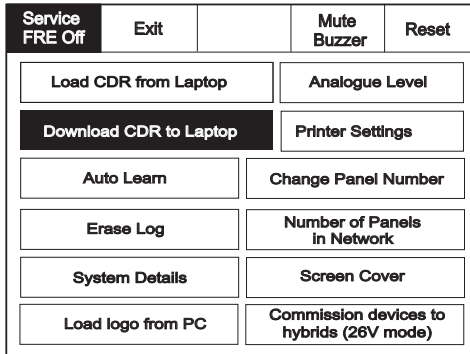
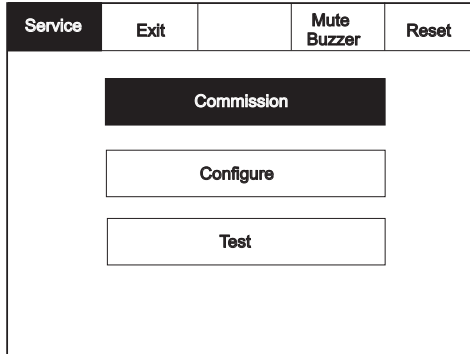

Select "Download CDR to Laptop" from the commission menu screen.

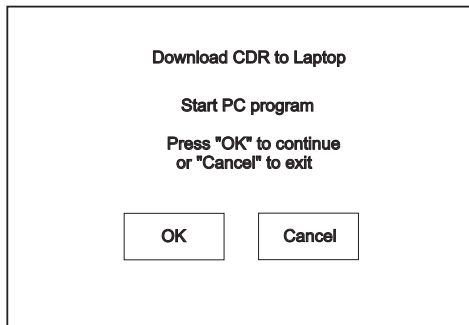

Auto learn

To activate the touch screen, touch the top left corner of the screen until the screen illuminates. To enter the supervisor mode touch the supervisor button and enter the service passcode.

Enter the Service Mode and Select Commission.

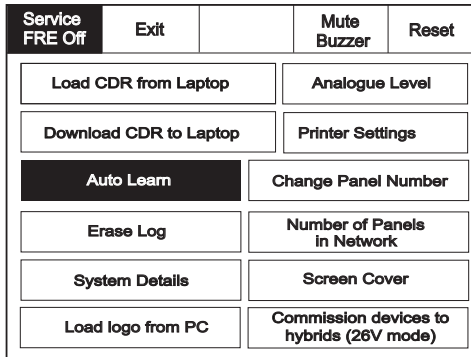
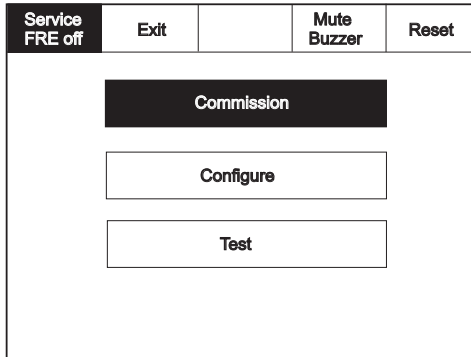

Select "Auto Run" from the configure menu screen.

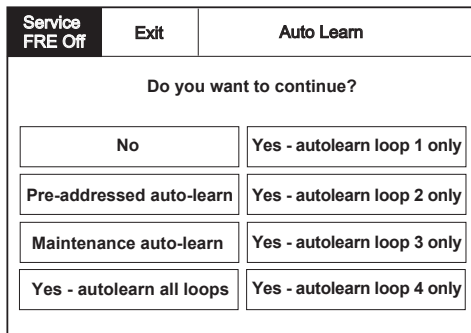

IMPORTANT:
Activating autolearn will erase all existing programming, text and configuration data.

Panel controls & indicators

Erase log

To activate the touch screen, touch the top left corner of the screen until the screen illuminates. To enter the supervisor mode touch the supervisor button and enter the service passcode.

Enter the Service Mode and Select Commission.

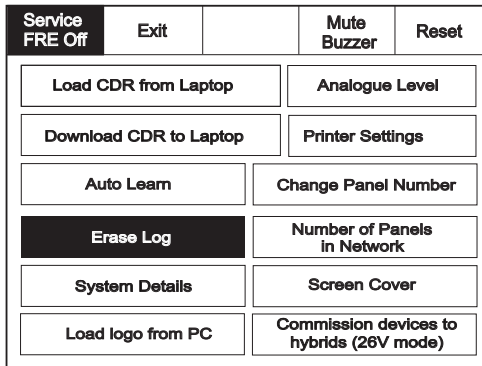
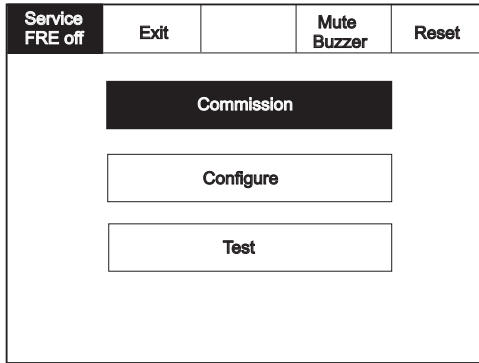

Select "Erase Log" from the configure menu screen.

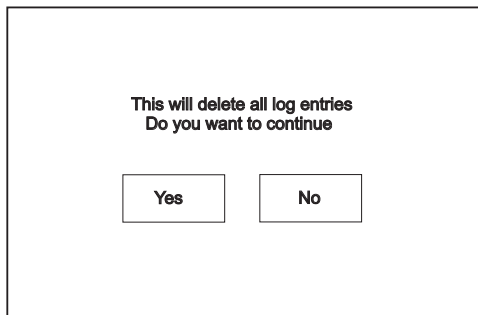

System details

To activate the touch screen, touch the top left corner of the screen until the screen illuminates. To enter the supervisor mode touch the supervisor button and enter the service passcode.

Enter the Service Mode and Select Commission, then Press "System Details"

Service FRE off	Exit		Mute Buzzer	Reset
Commission				
Configure				
Test				

Service FRE Off	Exit		Mute Buzzer	Reset
Load CDR from Laptop		Analogue Level		
Download CDR to Laptop		Printer Settings		
Auto Learn		Change Panel Number		
Erase Log		Number of Panels in Network		
System Details		Screen Cover		
Load logo from PC		Commission devices to hybrids (26V mode)		

Service FRE off	Print	Exit		Reset
Program	V3.02.01			
Program Data	22/01/08			
Program Checksum	0xAA9524			
CDR	V0.5			
CDR Checksum	0xF7D95E			
Loop Controller 1	V2.1.4			
Loop Controller 2	V0.0.0			
Panel Number	0			
Total Panels	1			
Total Addresses	13			
Total Zones	4			
Page 1		Page 2		Page 3

Service FRE off	Print	Exit		Reset
	Loop 1	Loop 2	Loop 3	Loop 4
Optical	0	0	0	0
Ionisation	13	14	0	0
Thermal A1R	0	0	0	0
Opto/Thermal	0	0	0	0
Thermal BS	0	0	0	0
Thermal CS	2	1	0	0
Call Point	0	0	0	0
Alarm	0	0	0	0
I/O Units	0	0	0	0
Page 1		Page 2		Page 3

Service FRE off	Print	Exit		Reset
	Loop 1	Loop 2	Loop 3	Loop 4
SCU	0	0	0	0
Voice Annunciator	13	14	0	0
Repeater	0	0	0	0
ZMU/SUM	0	0	0	0
Beam Detector	0	0	0	0
Technical Timer	2	1	0	0
Access Control	0	0	0	0
Emerg.Light.Module	0	0	0	0
Carbon Monoxide	0	0	0	0
Page 1		Page 2		Page 3

Panel controls & indicators

Analogue level

To activate the touch screen, touch the top left corner of the screen until the screen illuminates. To enter the supervisor mode touch the supervisor button and enter the service passcode.

Enter the Service Mode and Select Commission, then Press "Analogue Levels."

Service FRE Off	Exit		Mute Buzzer	Reset
Commission				
Configure				
Test				

Service FRE Off	Exit		Mute Buzzer	Reset
Load CDR from Laptop		Analogue Level		
Download CDR to Laptop		Printer Settings		
Auto Learn		Change Panel Number		
Erase Log		Number of Panels In Network		
System Details		Screen Cover		
Load logo from PC		Commission devices to hybrids (26V mode)		

Service FRE off	Exit	Goto		Reset
Show All	Show Detectors	Show Optical	Show Ionisation	Show Thermal
001 Device 1, Zone 1 Loop: 1, Zone: 1, Type: Opto/thermal				↑
002 Device 2, Zone 1 Loop: 1, Zone: 1, Type: Opto/thermal				
003 Device 3, Zone 1 Loop: 1, Zone: 1, Type: Opto/thermal				
004 Device 4, Zone 1 Loop: 1, Zone: 1, Type: Opto/thermal				
005 Device 5, Zone 1 Loop: 1, Zone: 1, Type: Opto/thermal				↓

Enter Address	1	2	3
.....			
Loop 1 0 - 13	4	5	6
Loop 2 0 - 0			
Loop 3 0 - 0	7	8	9
Loop 4 0 - 0			
Cancel	ok	0	←

Note: go to command can be used to jump to a specific address

Service FRE off	Exit	Previous	Next	Reset
Address 5			Optical	
Ground floor			Enabled	
Address 5	Current	21	Alarm >=	60
Panel 2	Min	21	PreAlarm	49
Loop 1	Max	21	Fault <=	5

Supervisor FRE off	Evacuate	Silence Alarms	Mute Buzzer	Reset
View Fires AC = 1378	View Pre Alarms	View Disabled	View Faults	Others
Enable/Disable	Weekly Test	Send Log to PC		
Print	View Log	Check Config.		
Lamp Test	Send analogue values to PC			

Printer settings

To activate the touch screen, touch the top left corner of the screen until the screen illuminates. To enter the supervisor mode touch the supervisor button and enter the service passcode.

Enter the Service Mode and Select Commission, then Press “Printer settings”

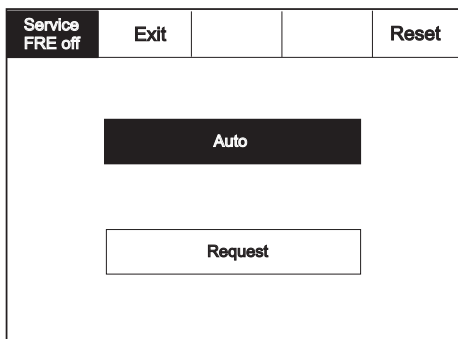
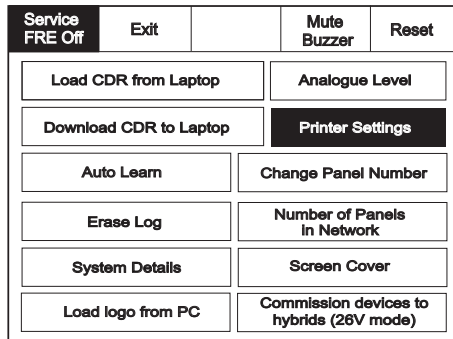
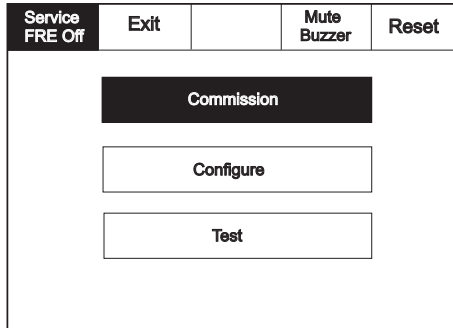

Panel controls & indicators

Change panel number

To activate the touch screen, touch the top left corner of the screen until the screen illuminates. To enter the supervisor mode touch the supervisor button and enter the service passcode.

Enter the Service Mode and Select Commission, then Press "Change Panel Number".

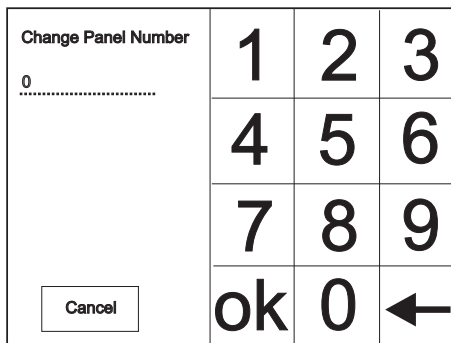
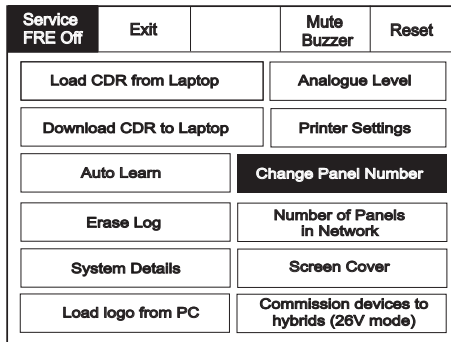
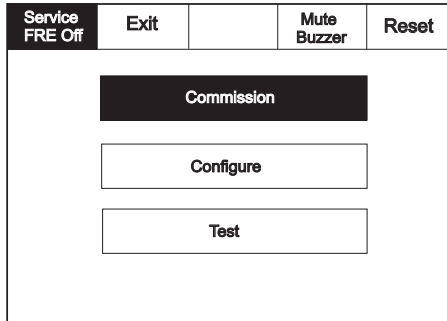

Number of panels in network

To activate the touch screen, touch the top left corner of the screen until the screen illuminates. To enter the supervisor mode touch the supervisor button and enter the service passcode.

Enter the Service Mode and Select Commission, then Press "Number of Panels in Network".

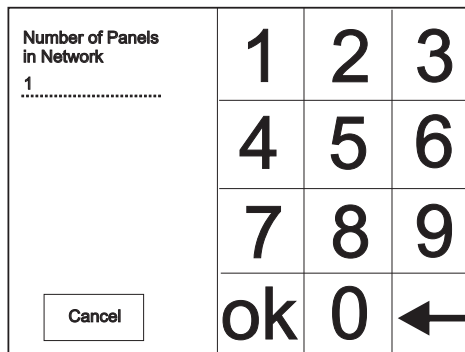
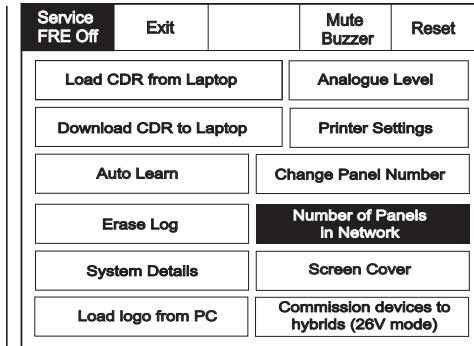
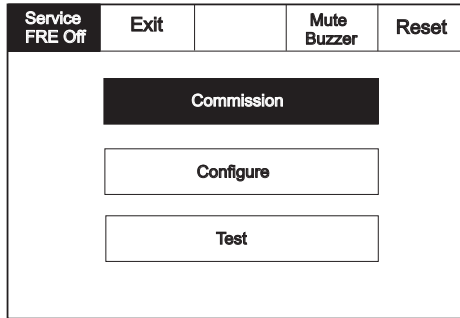

Panel controls & indicators

Screen cover

To activate the touch screen, touch the top left corner of the screen until the screen illuminates. To enter the supervisor mode touch the supervisor button and enter the service passcode.

Enter the Service Mode and Select Commission, then Press "Screen Cover"

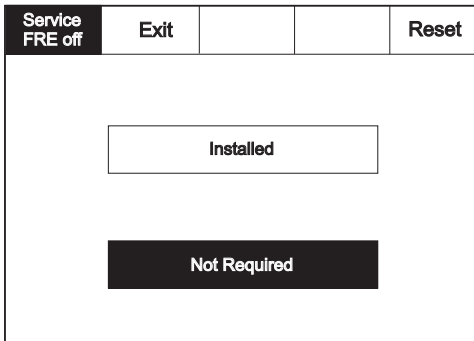
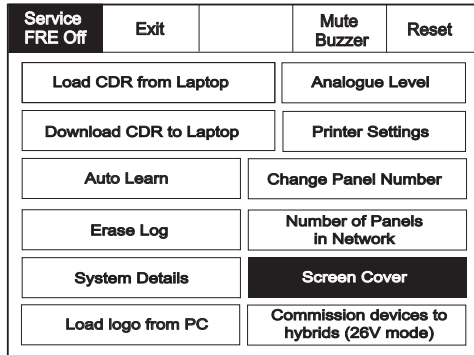
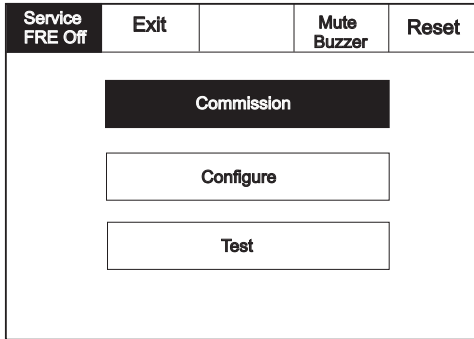

Programming I/O and sounders

To activate the touch screen, touch the top left corner of the screen until the screen illuminates. To enter the supervisor mode touch the supervisor button and enter the service passcode.

Enter the Service Mode and Select "Configure".

Service FRE off	Exit		Mute Buzzer	Reset
<div style="border: 1px solid black; width: 200px; margin: 10px auto; padding: 5px;">Commission</div> <div style="background-color: black; color: white; width: 200px; margin: 10px auto; padding: 5px; text-align: center;">Configure</div> <div style="border: 1px solid black; width: 200px; margin: 10px auto; padding: 5px;">Test</div>				

Service FRE off	Exit		Mute Buzzer	Reset
Programming I/O and Sounders		Add/Delete		
Change Date/Time		Configure Heat Detectors		
Change Text		Network		
Configure Zones		Language		
Change Passcode		Day/Night		
Italian Mode		Network Protocol		

Select "Programming I/O and Sounders" from the configure menu screen.

Service FRE off	Exit			Reset
Sound Settings		T1/T2		
Auxillary Board		Alarm Verification Feature		
FRE impedance band				
HMO		FRE double-knock Override		
Sounder tone				

Panel controls & indicators

Sound settings

1. Touch "Sound settings"

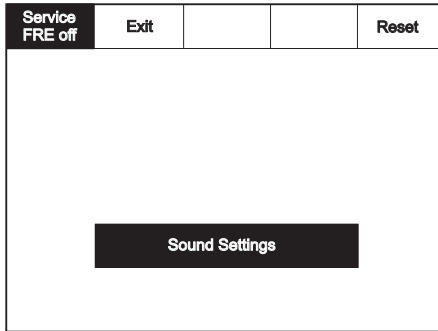

2. Selections from the screens below will become the global settings for all loop sounders.

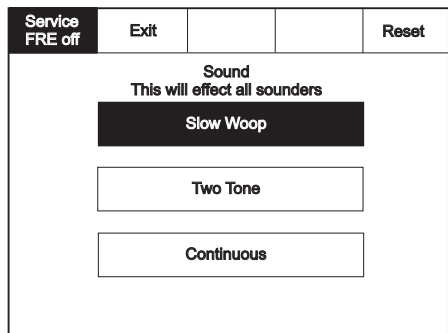
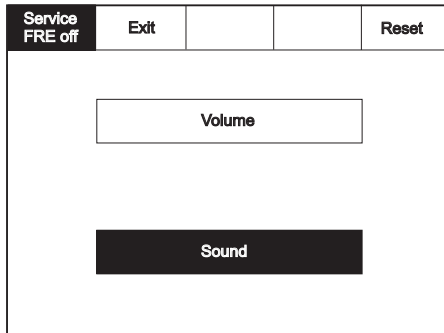
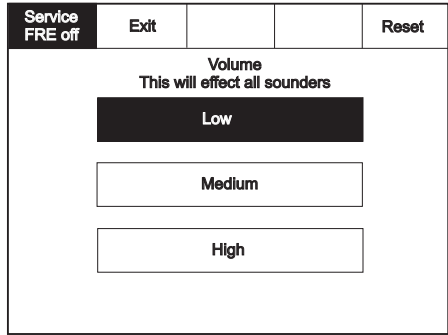
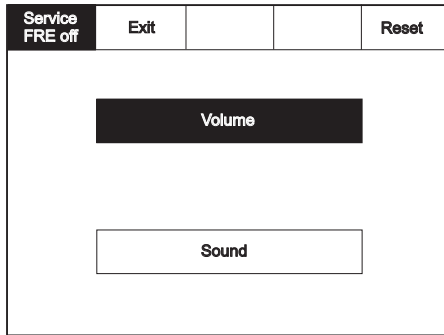

Change date/time

1. Enter the Service Mode and Select Configure. Select "Change Date/Time"

Service FRE off	Exit		Mute Buzzer	Reset
Programming I/O and Sounders		Add/Delete		
Change Date/Time		Configure Heat Detectors		
Change Text		Network		
Configure Zones		Language		
Change Passcode		Day/Night		
Italian Mode		Network Protocol		

2. Set the Time Using the Buttons Shown Below.

Service FRE Off	Ok	Cancel		Reset
Current Time:		+1 Hour	+10 Mins	+1 Mins
10:16:12		-1 Hour	-10 Mins	-1 Mins
BST On				
Current Date:		+1 Day	+1 Month	+1 Year
Wednesday dd-mmm-yyyy		-1 Day	-1 Month	-1 Year

Panel controls & indicators

Change text

1. Enter the Service Mode and Select Configure. Select "Change Text"

Service FRE off	Exit		Mute Buzzer	Reset
Programming I/O and Sounders		Add/Delete		
Change Date/Time		Configure Heat Detectors		
Change Text		Network		
Configure Zones		Language		
Change Passcode		Day/Night		
Italian Mode		Network Protocol		

2. Press "Change Address Text"

Service FRE Off	Exit		Mute Buzzer	Reset
Change address text				
Change zone text				
Change Panel Text				

3. Select the Address you wish to change and edit using the keyboard

Service FRE Off	Exit			Reset
Show All	Show Detectors	Show Alarms	Show I/O Units	
001 Device 1, Zone 1 Loop: 1, Zone: 1, Type : Opto/thermal				↑
002 Device 2, Zone 1 Loop: 1, Zone: 1, Type : Opto/thermal				
003 Device 3, Zone 1 Loop: 1, Zone: 1, Type : Opto/thermal				
004 Device 4, Zone 1 Loop: 1, Zone: 1, Type : Opto/thermal				
005 Device 5, Zone 1 Loop: 1, Zone: 1, Type : Opto/thermal				↓



Name for address 1											
Address1.....											
											←
1	2	3	4	5	6	7	8	9	0		
Q	W	E	R	T	Y	U	I	O	P		
A	S	D	F	G	H	J	K	L			
CAPS	Z	X	C	V	B	N	M	,	.		
OTHER	SPACE					OK		CANCEL			

Change zone text

1. Enter the Service Mode and Select Configure. Select "Change Text"

Service FRE off	Exit		Mute Buzzer	Reset
Programming I/O and Sounders		Add/Delete		
Change Date/Time		Configure Heat Detectors		
Change Text		Network		
Configure Zones		Language		
Change Passcode		Day/Night		
Italian Mode		Network Protocol		

2. Press "Change Zone Text"

Service FRE Off	Exit		Mute Buzzer	Reset
<div style="border: 1px solid black; padding: 5px; margin: 10px auto; width: 80%;">Change address text</div> <div style="background-color: black; color: white; padding: 5px; margin: 10px auto; width: 80%;">Change zone text</div> <div style="border: 1px solid black; padding: 5px; margin: 10px auto; width: 80%;">Change Panel Text</div>				

3. Select the zone you wish to Change and Edit Using the Keyboard.

Service FRE Off				Reset
Exit				
Zone 001 Zone 1				↑
Zone 002 Zone 2				↓
Zone 003 Zone 3				
Zone 004 Zone 4				

→

Enter the name for Zone 2									
Zone 2.....									←
1	2	3	4	5	6	7	8	9	0
Q	W	E	R	T	Y	U	I	O	P
A	S	D	F	G	H	J	K	L	
CAPS	Z	X	C	V	B	N	M	,	.
OTHER		SPACE			OK		CANCEL		

Panel controls & indicators

Change panel text

1. Enter the Service Mode and Select Configure. Select “Change Text”

Service FRE off	Exit		Mute Buzzer	Reset
Programming I/O and Sounders		Add/Delete		
Change Date/Time		Configure Heat Detectors		
Change Text		Network		
Configure Zones		Language		
Change Passcode		Day/Night		
Italian Mode		Network Protocol		

2. Press “Change Panel Text”

Service FRE Off	Exit			Reset
<div style="border: 1px solid black; padding: 5px; margin: 10px auto; width: 80%;">Change address text</div> <div style="border: 1px solid black; padding: 5px; margin: 10px auto; width: 80%;">Change zone text</div> <div style="background-color: black; color: white; padding: 5px; margin: 10px auto; width: 80%; text-align: center;">Change Panel Text</div>				

Correct Panel Text									
DF6000.....									←
1	2	3	4	5	6	7	8	9	0
Q	W	E	R	T	Y	U	I	O	P
	A	S	D	F	G	H	J	K	L
CAPS	Z	X	C	V	B	N	M	,	.
OTHER		SPACE			OK		CANCEL		

Configure zones

1. Enter the Service Mode and Select Configure. Select “Configure Zones”

Service FRE off	Exit		Mute Buzzer	Reset
Programming I/O and Sounders		Add/Delete		
Change Date/Time		Configure Heat Detectors		
Change Text		Network		
Configure Zones		Language		
Change Passcode		Day/Night		
Italian Mode		Network Protocol		

2. Select Zone into which device will be added.

Service FRE Off			Exit	Reset
Touch row to configure				
Zone 001 Zone 1				
Zone 002 Zone 2				
Zone 003 Zone 3				
Zone 004 Zone 4				

Service FRE Off	Exit	Goto		Reset
Show All	Show Detectors	Show Alarms	Show I/O Units	Show Selected
001 Device 1, Zone 1 Loop: 1, Zone: 1, Type : Opto/thermal			In Zone	↑
002 Device 2, Zone 1 Loop: 1, Zone: 1, Type : Opto/thermal			In Zone	
003 Device 3, Zone 1 Loop: 1, Zone: 1, Type : Opto/thermal			In Zone	
004 Device 4, Zone 2 Loop: 1, Zone: 2, Type : Opto/thermal			- ←	
005 Device 5, Zone2 Loop: 1, Zone: 2, Type : Opto/thermal			-	↓

Touch the dash to move the device into the selected zone.

Panel controls & indicators

Change user code

Enter the Service Mode and Select Configure. Select "Change User Code."

Service FRE off	Exit		Mute Buzzer	Reset
Programming I/O and Sounders		Add/Delete		
Change Date/Time		Configure Heat Detectors		
Change Text		Network		
Configure Zones		Language		
Change Passcode		Day/Night		
Italian Mode		Network Protocol		



Service FRE off	Exit		Mute Buzzer	Reset
<div style="border: 1px solid black; padding: 5px; width: fit-content; margin: 10px auto;">Change Engineering code</div> <div style="border: 1px solid black; padding: 5px; width: fit-content; margin: 10px auto;">Change User code</div>				



Please enter Passcode:	1	2	3
.....			
New Code:	4	5	6
.....			
Verify New Code:	7	8	9
.....			
<input type="button" value="Cancel"/>	ok	0	←

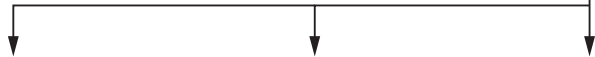

<p>Passcode is not correct. No change made</p> <div style="border: 1px solid black; padding: 5px; width: 40px; margin: 0 auto;">Ok</div>
--

<p>Verification is Incorrect No change made</p> <div style="border: 1px solid black; padding: 5px; width: 40px; margin: 0 auto;">Ok</div>

<p>New Password accepted Saved</p> <div style="border: 1px solid black; padding: 5px; width: 40px; margin: 0 auto;">Ok</div>
--

Add zone

Enter the Service Mode and Select Configure. Select "Add Zone".

Service FRE off	Exit		Mute Buzzer	Reset
Programming I/O and Sounders		Add/Delete		
Change Date/Time		Configure Heat Detectors		
Change Text		Network		
Configure Zones		Language		
Change Passcode		Day/Night		
Italian Mode		Network Protocol		

Service FRE Off	Exit			Reset				
<table border="1" style="margin: auto;"> <tr> <td>Add Zone</td> </tr> <tr> <td>Delete Zone</td> </tr> <tr> <td>Add Device</td> </tr> <tr> <td>Delete Device</td> </tr> </table>					Add Zone	Delete Zone	Add Device	Delete Device
Add Zone								
Delete Zone								
Add Device								
Delete Device								

<p>Add Zone ?</p> <table border="1" style="margin: auto;"> <tr> <td>Yes</td> <td>No</td> </tr> </table>		Yes	No
Yes	No		

Panel controls & indicators

Delete zone

1. Enter the Service Mode and Select Configure, select "Add/Delete" then "Delete Zone."

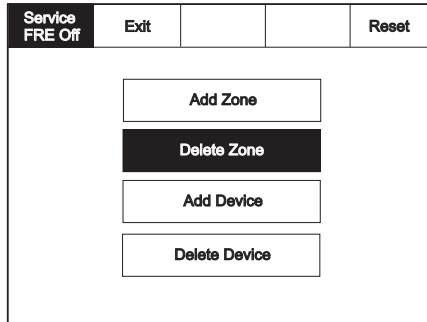

2. Select Zone to be Deleted

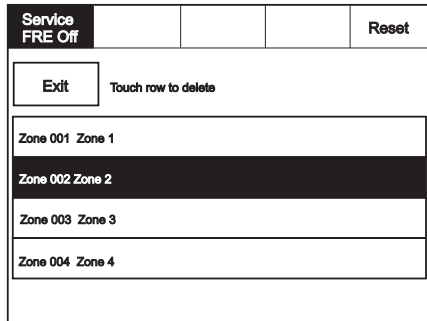

3. Confirm or Cancel Deletion

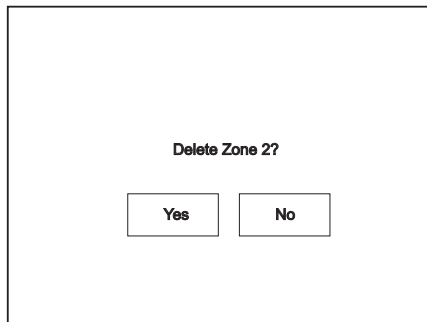

Add device

1. Enter the Service Mode and Select Configure, select "Add/Delete" then "Add Device":

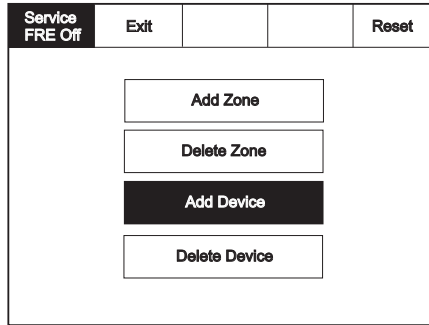

2. Select a Loop to Add a New Device

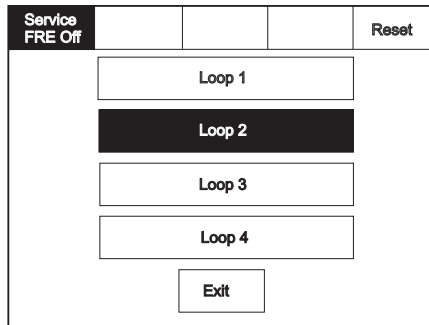

3. Confirm New Device and Loop

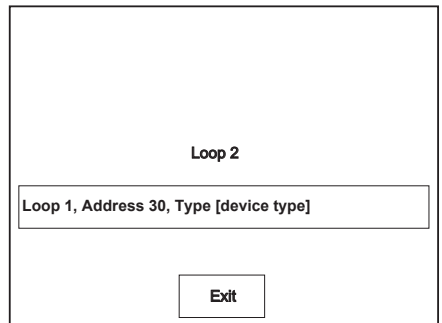
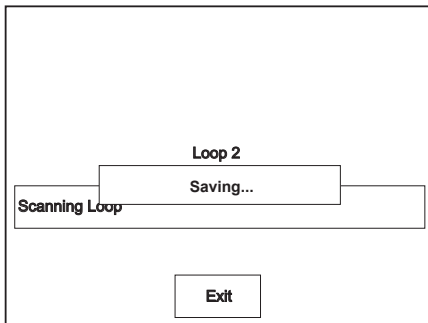

Panel controls & indicators

Delete device

1. Enter the Service Mode and Select Configure, select "Add/Delete" then "Delete Device"

Service FRE Off	Exit			Reset
<div style="border: 1px solid black; width: 100px; margin: 5px auto; padding: 5px;">Add Zone</div> <div style="border: 1px solid black; width: 100px; margin: 5px auto; padding: 5px;">Delete Zone</div> <div style="border: 1px solid black; width: 100px; margin: 5px auto; padding: 5px;">Add Device</div> <div style="border: 1px solid black; width: 100px; margin: 5px auto; padding: 5px; background-color: black; color: white;">Delete Device</div>				

2. Select a Device to Delete

Service FRE Off	Exit	Goto		Reset
Touch row to delete				
001 Device 1, Zone 1 Loop: 1, Zone: 1, Type : Opto/thermal				↑
002 Device 2, Zone 2 Loop: 1, Zone: 2, Type : Opto/thermal				
003 Device 3, Zone 1 Loop: 1, Zone: 2, Type : Opto/thermal				
004 Device 4, Zone 2 Loop: 1, Zone: 2, Type : Opto/thermal				
005 Device 5, Zone 1 Loop: 1, Zone: 1, Type : Opto/thermal				↓

3. Confirm or Cancel Deletion

Delete Device 3? Device 3 Loop 1, Address 3, Device Type Opto/thermal
<div style="border: 1px solid black; width: 100%; padding: 5px; margin: 5px;">Yes</div> <div style="border: 1px solid black; width: 100%; padding: 5px; margin: 5px;">Yes, but keep settings</div> <div style="border: 1px solid black; width: 100%; padding: 5px; margin: 5px;">No</div>

Configure heat detectors

1. Enter the Service Mode and Select Configure.
Select "Configure Heat Detectors"

Service FRE off	Exit		Mute Buzzer	Reset
Programming I/O and Sounders		Add/Delete		
Change Date/Time		Configure Heat Detectors		
Change Text		Network		
Configure Zones		Language		
Change Passcode		Day/Night		
Italian Mode		Network Protocol		

2. Select a Device to Configure.

Service FRE Off	Exit	Goto		Reset
Touch row to configure				
001 Device 1, Zone 1 Loop: 1, Zone: 1, Type : Opto/thermal				↑
002 Device 2, Zone 2 Loop: 1, Zone: 2, Type : Opto/thermal				
003 Device 3, Zone 1 Loop: 1, Zone: 2, Type : Opto/thermal				
004 Device 4, Zone 2 Loop: 1, Zone: 2, Type : Opto/thermal				
005 Device 5, Zone 1 Loop: 1, Zone: 1, Type : Opto/thermal				↓

3. Select appropriate detector class.

Service FRE Off				Reset
Thermal A1R				
Thermal BS				
Thermal CS				
Exit				

Panel controls & indicators

Network

Enter the Service Mode and Select Configure. Select "Network", This menu defines whether messages are broadcast across the network or remain local.

Service FRE off	Exit	Mute Buzzer	Reset
Programming I/O and Sounders		Add/Delete	
Change Date/Time		Configure Heat Detectors	
Change Text		Network	
Configure Zones		Language	
Change Passcode		Day/Night	
Italian Mode		Network Protocol	

Service FRE Off	Exit	Receive message over network
	Reset	Network
	Evacuate	Network
	Silence	Network
	Fire	Network
	Fault	Network
	Pre-Alarm	Network

Supervisor FRE Off	Evacuate	Silence alarms	Mute buzzer	Reset
Exit	Receive messages from networked panels			
Panel 001				Enabled
Panel 002				Enabled
Panel 003				Enabled
Panel 004				Enabled
Panel 005				Enabled

Password protection

The Eaton Fire Systems control panel system has password protection which restricts access to the DISABLE Menu and to TEST/COMMISSIONING MODE. The password is a four digit code and the default number is 2214. The password entry screen is accessed via the supervisor mode button. Press supervisor mode and the password entry screen will be displayed, type in the passcode and press Ok. If the wrong password is entered three times further access to the system is denied

Service FRE Off	1	2	3
Please enter Passcode -----	4	5	6
	7	8	9
Cancel	ok	0	←

Appendix System wiring

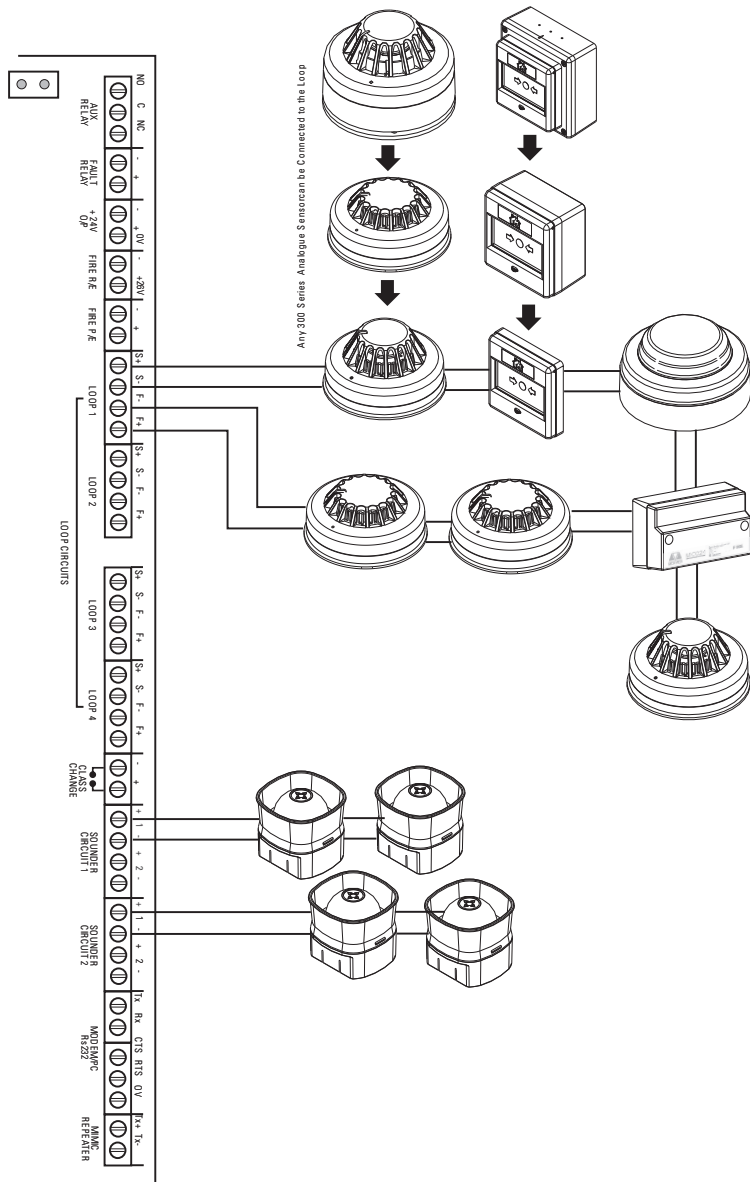

Appendix

Detector base wiring (CAB300)

Supply voltage	18 - 30 V DC
Cable size	1.0 - 1.5mm ²
Recommended cable types	FIRETUF, FP200 or MICC
Mounting hole centres	50 - 80mm

Wiring hints

- Each terminal is suitable for clamping up to 2 wires
- Clamping of 2 wires of very different diameters under one screw is not recommended
- Suitable for mounting to mounting boxes with 50-80mm fixing centres

General

If difficulty is experienced when mounting the sensor, this may be due to the following:

- Wiring causing an obstruction - move or shorten wires
- Although the base is tolerant to uneven mounting surfaces, a very uneven surface may cause the base to deform when the mounting screws are tightened down - loosen screws to reduce this or slide base to a flat position

WARNING

DO NOT USE HIGH VOLTAGE TESTERS WHEN SENSORS OR CONTROL PANEL ARE CONNECTED TO THE SYSTEM.

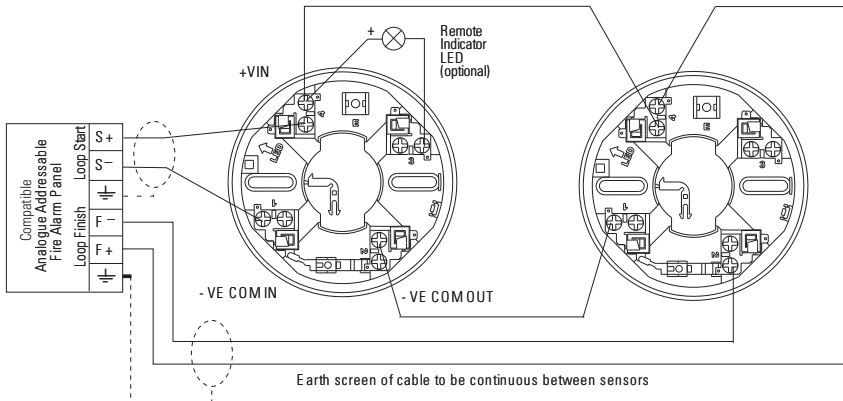

Call point wiring (CBG370S/CBG370WP)

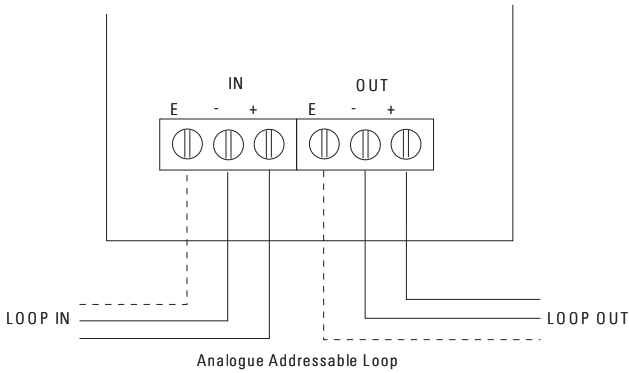

Base sounder wiring (CAS380, CASBB384)

Supply voltage	17 ~ 32 Vdc
Cable size / type	1.0 ~ 1.5mm ² / FIRETUF, FP200 or MICC
Standby current	< 320 uA
Operating temperature	-10 to +55 degrees C (95%RH)
Sound output @ +/-3dB (set by panel)	Low volume : 84dB @ <4mA Medium volume : 92dB @ <8mA High volume : 95dB @ <12mA
Tones (set by panel)	Continuous 910Hz Pulsed 910Hz / 0Hz pulse 1Hz Two tone 610 / 910Hz @ 1Hz cycle Slow whoop 500-1200Hz in 3.5 seconds / 0.5secs gap

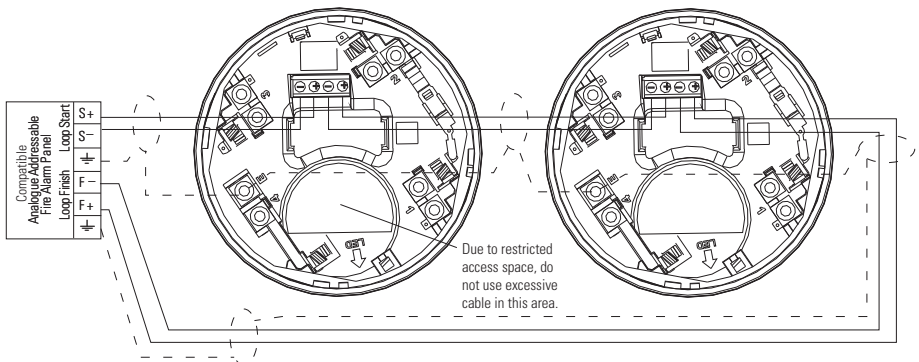

Appendix

Loop powered beacon wiring (CAB382)

Connection details

Earth screen of cable to be continuous between beacons

WARNING

Do NOT use high voltage testers if any equipment is connected to the system.

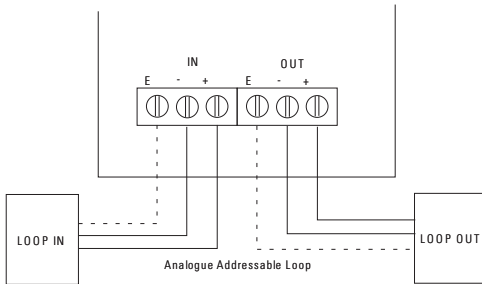

Wall sounder wiring (CAS381, CASB383)

Installation

Fix to mounting surface using two suitable screws - the rear gasket fits underneath the base and the sounder gasket fits inside the base

Connection

WARNING

Do NOT use high voltage testers if ANY equipment is connected to the system. Earth screen must be continuous along entire length of loop.

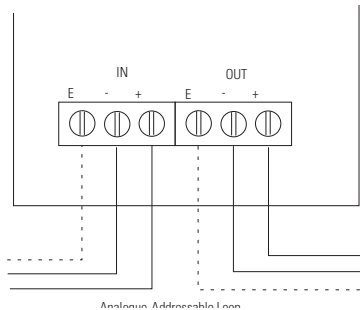

Note: Care should be taken to ensure the cable does not put stress on the circuit board

IP66 wall sounder wiring (CAS381WP, CASB383-WP)**Installation**

1. Drill required holes for the cable gland fixing
2. Drill out the required fixing holes
3. Fix to mounting surface using two suitable screws

Connections

⚠ WARNING

Do NOT use high voltage testers if ANY equipment is connected to the system. Earth screen must be continuous along entire length of loop.

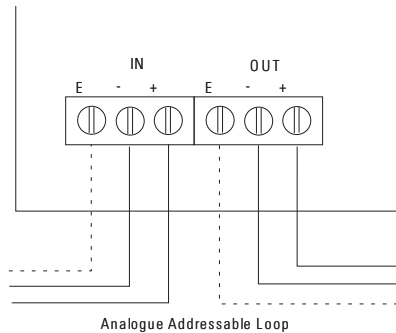

Appendix

Base Sounder VAD (CASBB394)

Installation

1. Installation is simple using first fix base.
2. First fix base is fixed to mounting surface via 2 fixings holes.
3. Cables enter through aperture in base (rear entry only).
4. Main body is then clipped into place on base, main body locks into place when pressed into position.
5. Cables pass through aperture in sounder body and terminate at the front.
6. Connections are to connector block on front of main sounder body.

System functionality

1. Volume and tone are set by control panel, no need to access sounder to alter setting.
2. Soft addressed.

Standard connections

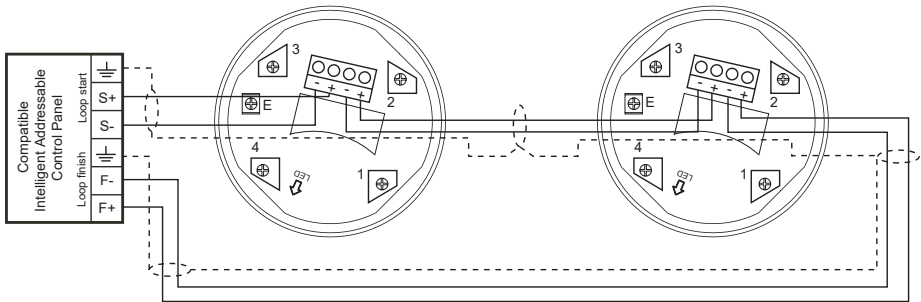

Note: Base terminal 1, 2, 3 and 4 not used. All wiring terminates as shown above.

⚠ WARNING

Do NOT use high voltage testers if ANY equipment is connected to the system. Earth screen must be continuous along entire length of loop.

Wall Sounder VAD (CASB393)

Installation

1. Installation is simple using first fix base.
2. First fix base is mounted to surface via 2 fixing holes.
3. Cable entry can be rear or side
4. Main body is then clipped into place on base, main body locks into place when pressed into position.
5. Cables pass through aperture in sounder body and terminate at the front.
6. Connections are to connector block on main sounder body.

System functionality

1. Volume and tone are set by control panel, no need to access sounder to alter setting.
2. Soft addressed.

Standard connections

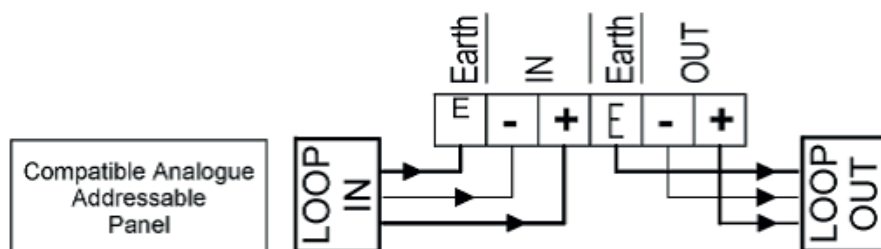

⚠ WARNING

Do NOT use high voltage testers if ANY equipment is connected to the system. Earth screen must be continuous along entire length of loop.

Appendix

IP66 Wall Sounder VAD (CASB393WP)

Installation

1. Installation is simple using first fix base.
2. First fix base is mounted to surface via 2 fixings holes.
3. Cable entry can be rear or side
4. Main body is then bolted into place on base.
5. Cables pass through aperture in sounder body and terminate at the front. Ensure cables are correctly sealed for IP66 integrity.
6. Connections are to connector block on main sounder body.

System functionality

1. Volume and tone are set by control panel, no need to access sounder to alter setting.
2. Soft addressed.

Standard connections

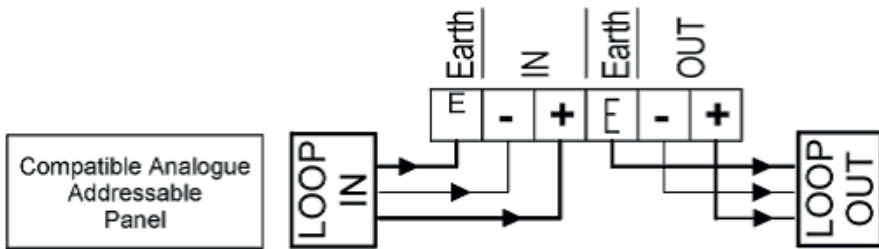

WARNING

Do NOT use high voltage testers if ANY equipment is connected to the system. Earth screen must be continuous along entire length of loop.

3 way input output unit (CIO351, CIO351S, CIO351SST)

Installation

1. Separate the two halves of the unit and remove the PCB before drilling (PCB can be added back in after).
2. Drill out (or knock out) the required cable entries in the surface mounting back-box
3. Fit the back-box in position and pass the wires into it
4. Connect the unit according to the diagram below

Note: No addressing of the interface is required. See control panel operation for details.

Standard connections

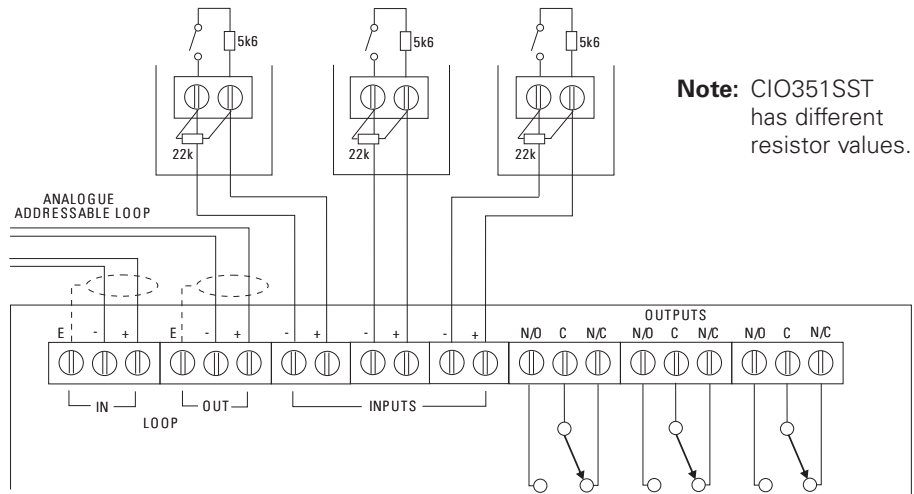

Note: No addressing of the interface is required. See control panel operation for details.

1. Only connect cable screen to its adjacent earth terminal
2. The end of line resistor must always be fitted, even if the inputs are unused
3. Monitored inputs can detect open or short circuit faults
4. Output relays are volt-free contacts and are not monitored

Appendix

1 Channel mains rated I/O unit wiring (CMIO353)

Installation

1. Separate the two halves of the unit and remove the PCB before drilling (PCB can be added back in after).
2. Drill out (or knock out) the required cable entries in the surface mounting back box
3. Fit the back-box in position and pass the wires into it
4. Connect the unit according the diagram below

Note: No addressing of the interface is required. See control panel operation for details

Standard connections

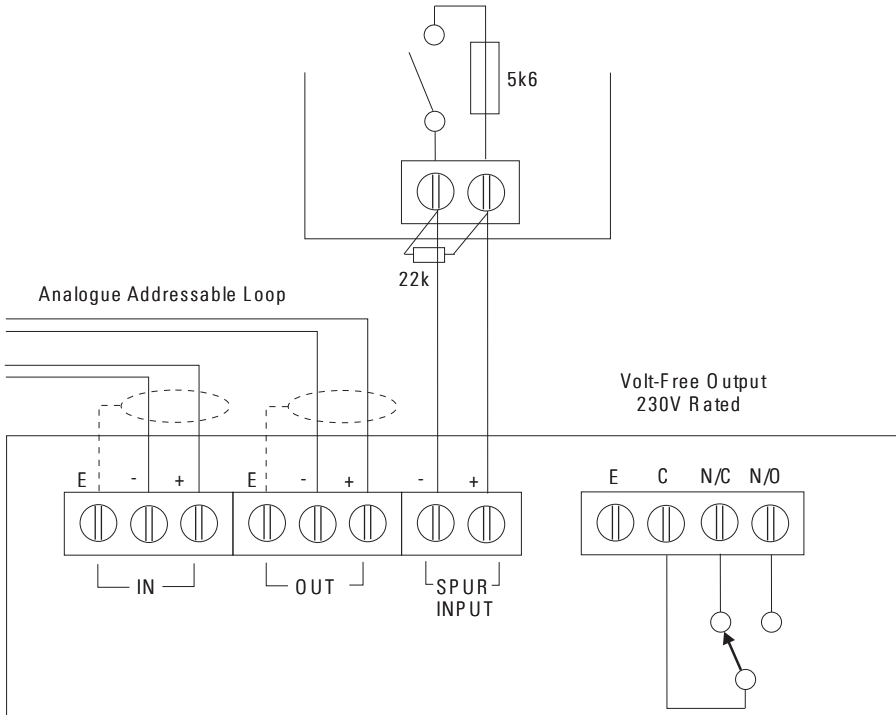

Note:

1. Only connect cable screen to its adjacent earth terminal
2. The end of line resistor must always be fitted, even if the spur is unused

Zone monitor unit wiring (CZMU352)

Installation

1. Separate the two halves of the unit
2. Drill out (or knock out) the required cable entries in the surface mounting back - box
3. Fit the back-box in position and pass the wires into it
4. Connect the unit according to the diagram below

Note: No addressing of the interface is required. See control panel operation for details

Standard Connections

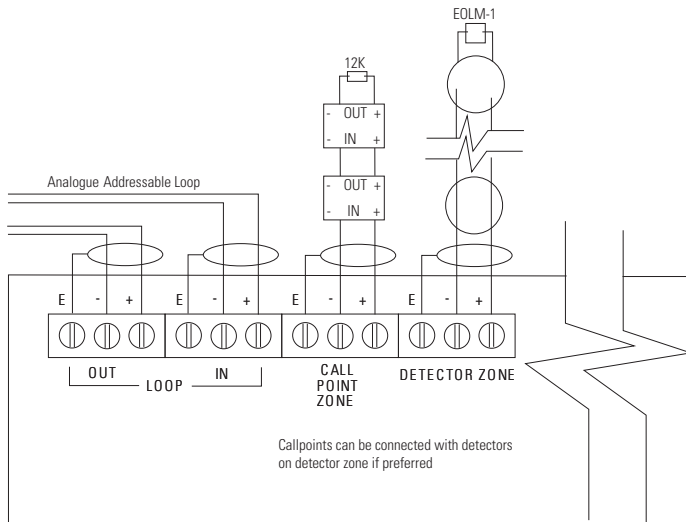

Note:

1. This unit can only be used with CDB300/I detector base and compatible detectors
2. Only connect cable screen to its adjacent earth terminal
3. The end of line resistor must always be fitted, even if the spur is unused
4. Maximum spur length - See BS5839 Pt1:2002 for Zone Coverage
5. Maximum number of call points allowed is unlimited
6. Detector zone end of line device is EOLM-1 (supplied)
7. Callpoint zone has end of line resistor

Appendix

Intrinsically safe zone monitor unit wiring (CZMU352-IS)

Installation

1. Separate the two halves of the unit
2. Drill out (or knock out) the required cable entries in the surface mounting backbox
3. Fit the back-box in position and pass the wires into it
4. Connect the unit according to the diagram below
5. Recommended Cable Type: FIRETUF, FP200, MICC

Note: No addressing of the interface is required. See control panel operation for details. There are no serviceable parts so no maintenance procedures apply

Standard connections

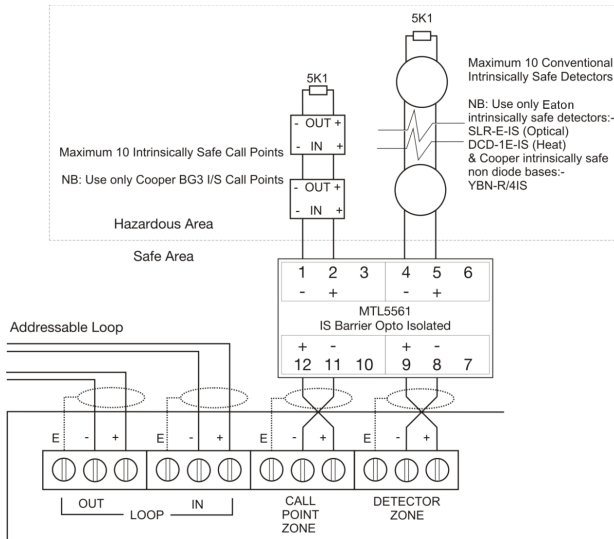

Note:

1. This detection zone can only be used with intrinsically safe detectors SLR-E-IS (optical) / DCD-1E-IS (Heat) with the non-diode base YBN-R/4IS
2. The call point zone can only be used with BG3 I/S call points
3. Only connect cable screen to its adjacent earth terminal
4. The end of line resistor must always be fitted, even if the spur is unused
5. Maximum spur length – See BS5839 Pt1:2001 for Zone Coverage

Shop monitor unit wiring (MSU840)

Installation

1. Separate the two halves of the unit
2. Drill out (or knock out) the required cable entries in the surface mounting back - box
3. Fit the back-box in position and pass the wires into it
4. Connect the unit according to the diagram below

Note: No addressing of the interface is required. See control panel operation for details

Standard connections

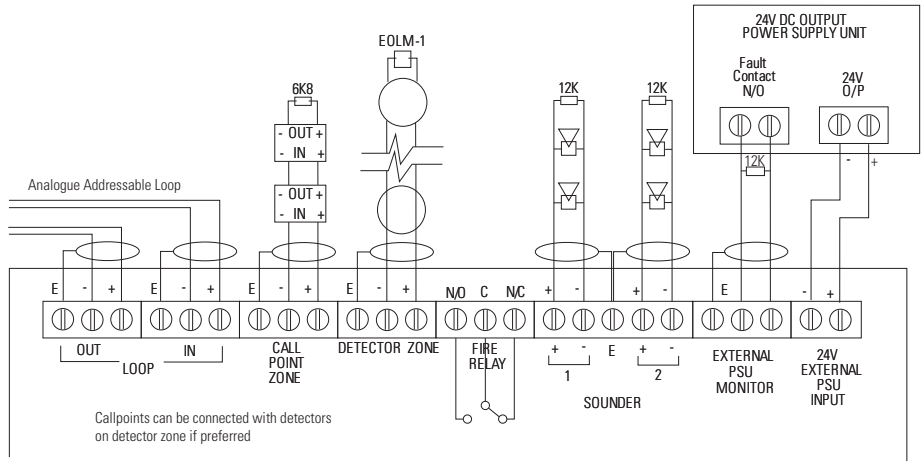

Note:

1. This unit can only be used with CDB300/I detector base and compatible detectors
2. Only connect cable screen to its adjacent earth terminal
3. The end of line resistor must always be fitted, even if the spur is unused
4. Maximum spur length - See BS5839 Pt1:2002 for Zone Coverage
5. Maximum number of call points allowed is unlimited
6. Detector zone end of line device is EOLM-1
7. Callpoint zone has end of line resistor

Appendix

Spur isolator wiring (CSI350)

Installation

1. Fit the unit in position
2. Connect the unit according to the diagram below

Note: A Spur Isolator must be used when making spurs from the analogue addressable panel loop. Without this unit, the self addressing features of the system will not function correctly. No addressing of the interface is required. See control panel operation for details

Standard connections

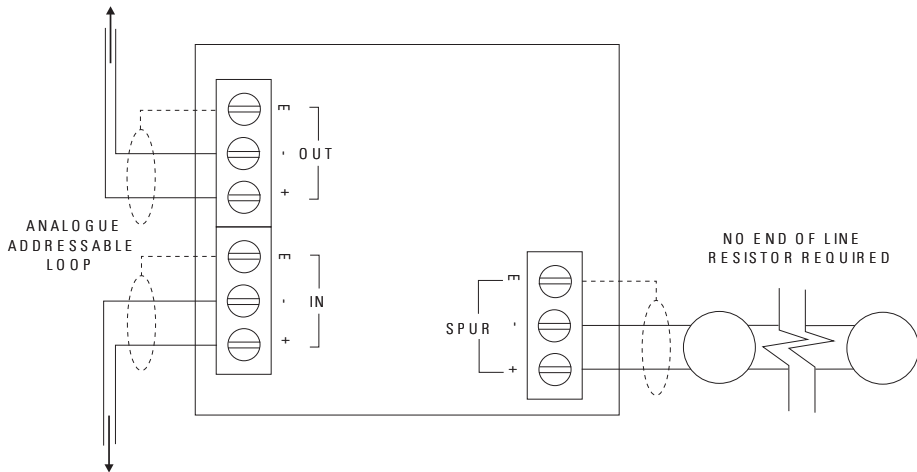

Note:

1. Only connect cable screen to its adjacent earth terminal
2. For maximum spur length / load see BS5839 Pt1:2002
3. This unit can only be used with Eaton CAB300 and CDB300/I Sensor bases and compatible sensors

4 Way sounder controller wiring (CSC354CPR)

Installation

1. Remove the cover of the unit
2. Fit the back-plate in position and pass the wires into it taking care not to damage the circuit board
3. Connect the unit according to the diagram below

Note: No addressing of the interface is required. See control panel operation for details. This unit requires a permanent 230V AC supply

Standard connections

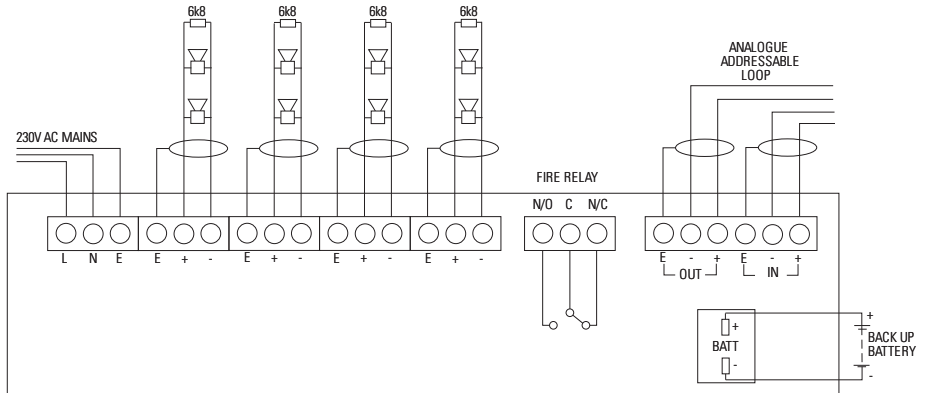

Note:

1. Only connect cable screen to its adjacent earth terminal
2. The end of line resistors must always be fitted, even if the sounder circuits are unused

Appendix

4-20mA interface wiring (CGI420, CIT420, CGI420R, CIT420R)

Installation

1. Separate the two halves of the unit
2. Drill out (or knock out) the required cable entries in the surface mounting back-box
3. Fit the back-box in position and pass the wires into it
4. Connect the unit according to the diagram below
5. Set the required threshold levels via the DIL switches

Standard connections

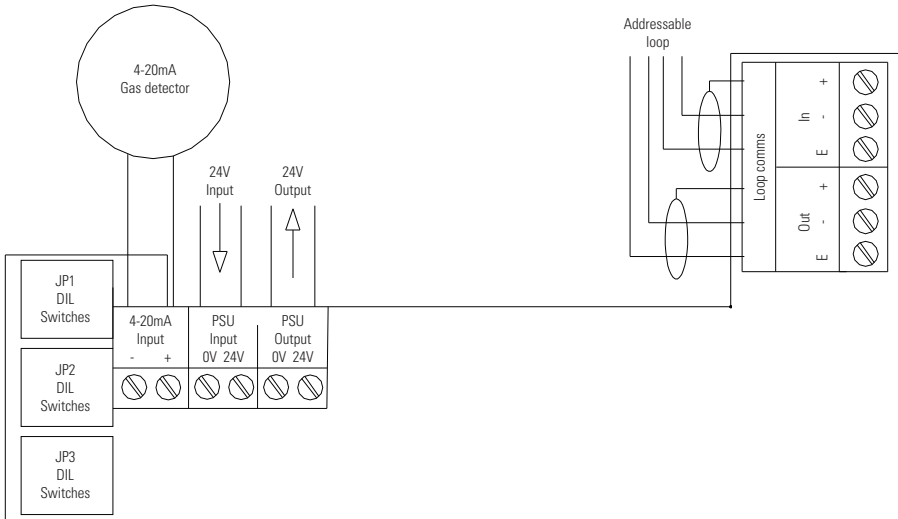

Note:

Recommended Loop Cable Type: FIRETUF, FP200, MICC No addressing of the interface is required. See control panel operation for details. There are no serviceable parts so no maintenance procedures apply

Micro zone monitor module wiring (CIU872)

Installation

1. Fit the box in position using the mounting details below
2. Connect the unit according to the diagram below
3. Recommended Loop Cable Type: FIRETUF, FP200, MICC

Note:

No addressing of the interface is required. See control panel operation for details. There are no serviceable parts so no maintenance procedures apply.

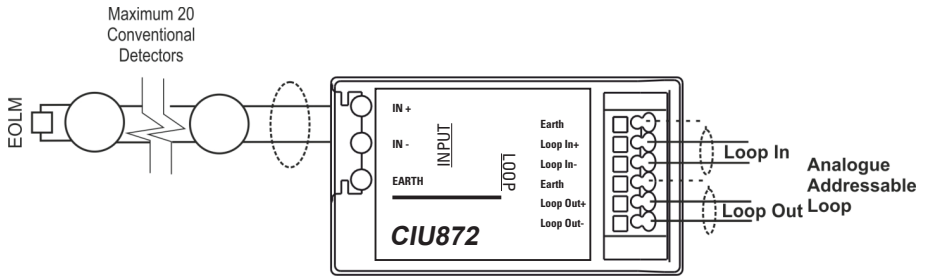

Standard connections

Note:

1. This unit can only be used with Eaton FXN520 detector base and compatible detectors
 2. Only connect cable screen to its adjacent earth terminal
 3. The end of line resistor must always be fitted, even if the spur is unused
 4. Maximum spur length – See BS5839 Pt1:2001 for Zone Coverage
 5. Maximum number of call points allowed is unlimited
- Detector zone end of line device is EOLM-1 (supplied)

Appendix

Micro input module wiring (MCIM)

Installation

1. Fit the box in position using the mounting details below.
2. Connect the unit according to the diagram below.
3. Recommended Loop Cable Type: FIRETUF, FP200, MICC

Note:

No addressing of the interface is required. See control panel operation for details. There are no serviceable parts so no maintenance procedures apply.

Standard connections

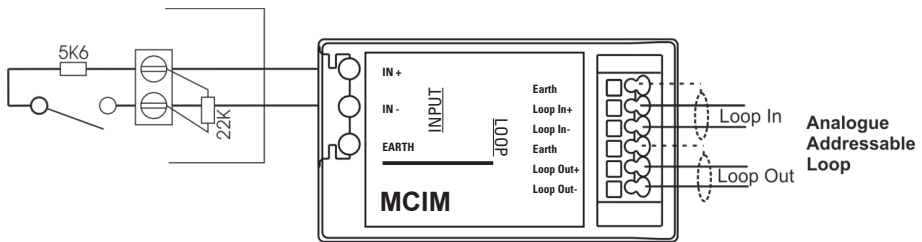

Note:

1. Only connect cable screen to its adjacent earth terminal
2. The end of line resistor provided must always be fitted, even if the input is unused
3. Monitored inputs can detect open or short circuit faults

Micro output module wiring (MCOM, MCOM-R, MCOM-S, MCOM-FC)

Installation

1. Fit the box in position using the mounting details below
2. Connect the unit according to the diagram below
3. Recommended Loop Cable Type: FIRETUF, FP200, MICC

Note:

No addressing of the interface is required. See control panel operation for details. There are no serviceable parts so no maintenance procedures apply.

Standard connections

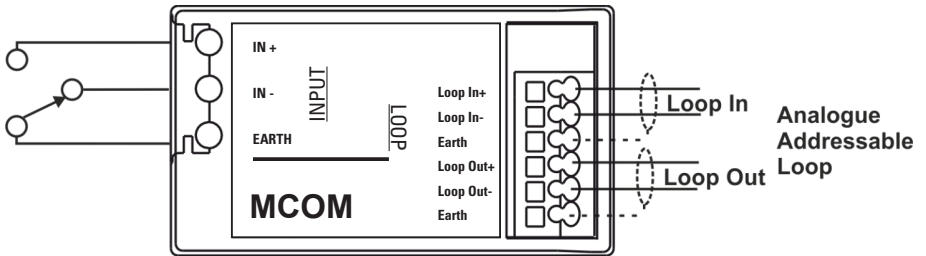

Note:

1. Only connect cable screen to its adjacent earth terminal
2. Output relay are volt-free contacts and are not monitored

Appendix

Typical smoke management topology diagram

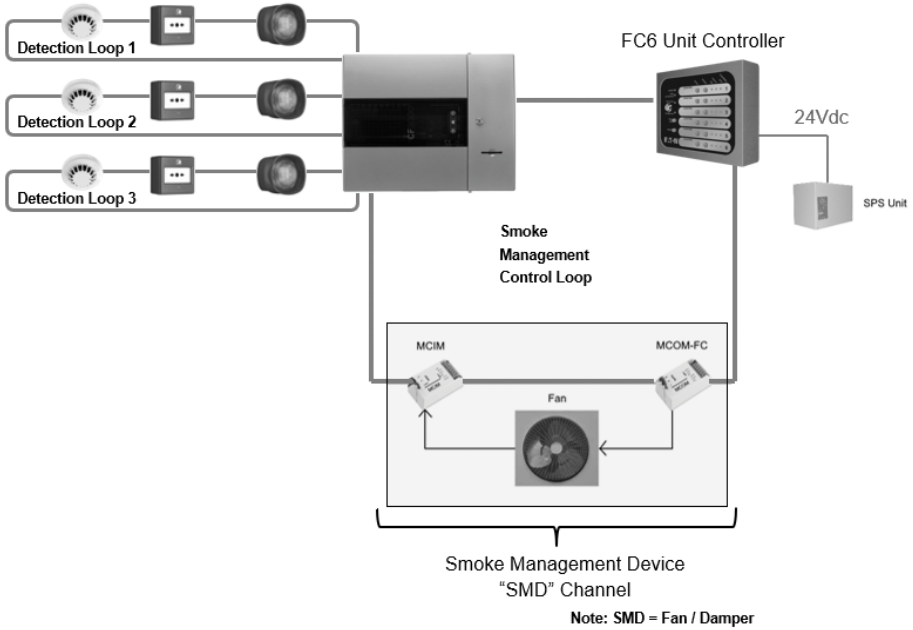

Grouped smoke management devices

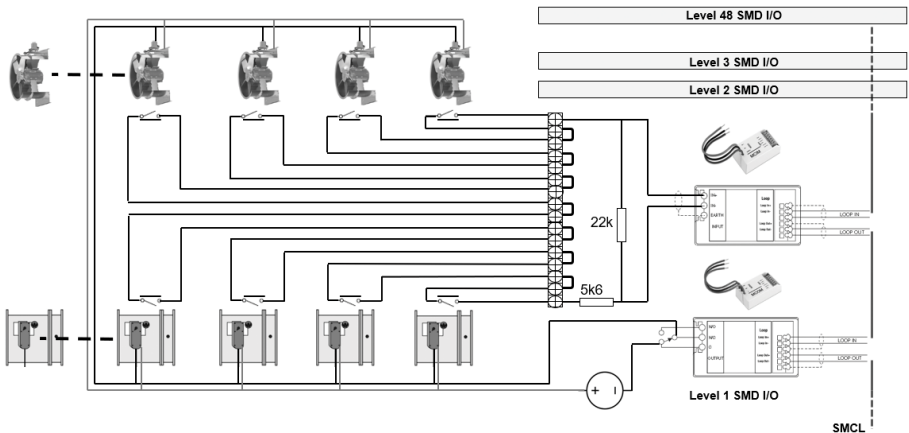

EN54 Spec label positioning

EN54 Product Spec Label

Note:

X=2 on a 2 Loop Panel or
X=4 on a 4 Loop Panel

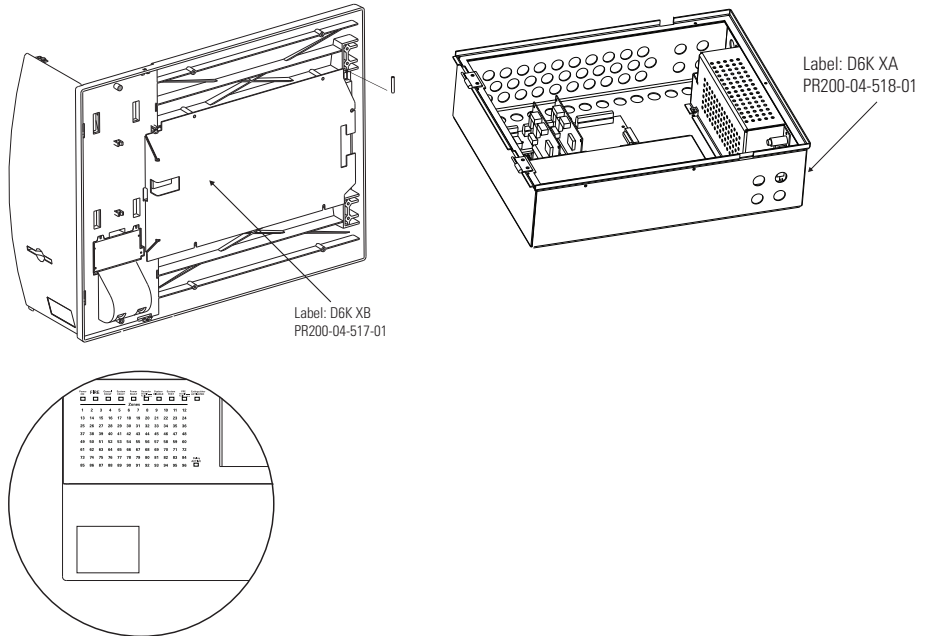



Note: If the panel is recessed this label must be placed on the front of the panel as indicated



Battery disposal instructions

Although batteries contain lead and small amounts of antimony and arsenic, they are safe if handled according to the accompanying guide. The battery cells must not be dismantled as this involves several hazards, which are best handled under controlled conditions, using specialised equipment. No attempt should be made to repair any batteries; they should be treated as disposable when they have outlived their use. Batteries must be disposed of in accordance with current waste disposal and pollution legislation and in particular; The Environment Protection Act 1990, Special Waste Regulation 1996. It is recommended that the following authorities are contacted before any attempt is made to dispose of batteries; Environment Agency Local office, Local Authority Environmental Health or Waste Handling department.

Appendix

CE marking

 2831 DoP0225	 714w/01
Eaton Electrical Systems Ltd Wheatley Hall Road Doncaster South Yorkshire DN2 4NB 09	
EN 54-2 1997 & A1:2006 CF3000 Control and Indicating equipment for fire detection and fire alarm systems for buildings EN 54-2 Clause Options Provided 7.8 Output to fire alarm devices 7.9.1 Output to fire alarm routing equipment 7.10.1 Output to automatic fire protection equipment (type A) 7.10.2 Output to automatic fire protection equipment (type B) 7.11 Delays to outputs 7.12.3 Dependences on more than one alarm signal-Type C 7.13 Alarm counter 8.9 Output to fault routing equipment 9.5 Disabling of each point 10 Test condition Other technical data: see Doc. 25-14682 held by the manufacturer	

 2831 DoP0225	 714w/01
Eaton Electrical Systems Ltd Wheatley Hall Road Doncaster South Yorkshire DN2 4NB 09	
EN 54-4 1997 & A1:2002 A2:2006 CF3000 Power supply equipment for fire detection and fire alarm systems for buildings Other technical data: see Doc. 25-14682 held by the manufacturer	



Assessed to ISO 9001:2008
 Certification number 714w/01
 Approved to EN54-2 1997 & A1;2006
 EN54-4:1997 & A1;2002 A2:2006



Powering Business Worldwide

Eaton Electrical Systems Ltd.

Wheatley Hall Road
Doncaster
South Yorkshire
DN2 4NB

Eaton

EMEA Headquarters
Route de la Longeraie 7
1110 Morges, Switzerland
Eaton.eu

© 2019 Eaton
All Rights Reserved
Publication No. 25-14682-C
December 2019

Eaton is a registered trademark.

All trademarks are property
of their respective owners.