

CTPR3000

TOUCHSCREEN REPEATER PANEL INSTALLATION MANUAL



Cooper Fire Systems
Security House,
Vantage Point Business Village
Mitcheldean
Gloucester
GL17 0SZ
United Kingdom
TEL: +44(0)1594 541900
FAX: +44(0)1594 541910

Introduction

Introduction to the Manual

This manual provides information on the installation, operation and maintenance of the Panel System.

NOTICE

The operating system of the panel may be revised as a result of enhancements to the system software or hardware. Revisions to this manual will be issued and supplied on request and should be logged in the table supplied on the contents page.

Contents

Contents	Page
1.0 System Design & Installation	
Introduction	7
Technical Specification	8
Cable and Wiring	10
Installation	11
Fixing details	12
External Connections	13
Networking	14
2.0 Commissioning the Panel	
Commissioning	16
3.0 Panel Controls and Indicators	
Panel Controls and Indicators	19
Touch Screen Display	20
Panel Operation	21
Public Access Level 1	22
Evacuate (Access Level 2)	23
Silence Alarms	24
Mute Buzzer	25
Pre-Alarms	26
Faults	27
Enable / Disable	27
Print (Function not available)	28
Lamp Test	29
View Events	30
Send Log to PC	31
Erase Log	32
System Details	33
Load Logo from PC	34
Repeater Mode	35
Printer Settings	36
Change Panel Number	38
Number of Panels in Network	39
Change Date/Time	40
Change Panel Text	41
Change Passcode	42
Relay Control	43
Programable Input	44
Network	45
Language	46
Network Protocol	47
Power Supply	48
Password Protection	49
4.0 Appendix	
System Wiring	51

Contents

Contents

Contents

Page

Section 1

System Installation and Design

Introduction

Analogue Touchscreen Repeater Panel CTPR3000

The CTPR3000 fire detection repeater panel provides sophisticated 'touch screen' functionality yet achieves a simple end-user interface operation within a compact panel design. The CTPR3000 is designed to work with Cooper Analogue Addressable Fire alarm Control Panels as a network repeater. It is fully compliant with the statutory requirement of EN60950 (LVD) and EN50130 (EMC) and includes an integral monitor PSU compliant with the latest requirements of EN54 pt4 together with a wide range of user controllable functions; make the panel suitable for a wide range of projects.

The Cooper repeater panel is easy to install and commission all text is transmitted via the network and is automatically updated and as the following features

- Plug and play. All information is downloading through the network
- Touch Screen Display
- Integrated Network capability allows networking with Cooper latest range of analogue addressable Fire Alarm Control Panels
- Multi language capability
- 2 programmable Auxiliary relays
- 24 Volts 500ma output
- Programmable input is available
- External Printer outputs
- Up to 1000 event log
- Optional local and external PSU
- PSU approved to EN54 pt4
- Utilises 2 core cables and up to 125 repeaters can be connected to the network
- Programmable as an active or Passive Repeater can be power locally or external 24 volts power supply

Technical Specification

Power Specification

Mains Fuse	: 1.6A Slow Blow
Nominal Voltage	: 230 Vac + 10%, -15%
Nominal Current	: 75mA

The Panel is protected by an internal thermal device, this requires no maintenance

Batteries

Number of Batteries	: 2
Manufacturer:	: YSP12-7
Capacity	: 7 Ah
Battery Fuse	: 4A Quick Blow (F4)
Maximum battery current;	: 3.5 Amps
Standby current (mA)	: 100 (1 loop)

Inputs

Programmable Input (TB10)

Link input to activate

Outputs

Programable Auxiliary Relays (TB8)

The programable auxiliary relays provide fused volt free change over contacts. These contacts are not monitored.

Max Load	: 24 Volts 1 Amp
Fuse (PTC4)	: 1.1 Amps polyswitch

Programable Fault Relays (TB7)

The programable fault relays provide fused volt free change over contacts. These contacts are not monitored.

Max Load	: 24 Volts 1 Amp
Fuse (PTC3)	: 1.1 Amps polyswitch

24V Input Supply (TB1)

Nominal Voltage	: 24 Volts \pm 10%
Fuse (PTC1)	: 1.1 Amps polyswitch
Maximum current	: 800 mA

Any power taken from the alarm system will effect the standby duration

24V Output Supply (TB2)

Nominal Voltage	: 24 Volts \pm 10%
Fuse (PTC2)	: 1.1 Amps polyswitch
Maximum current	: 500 mA

Technical Specification

Mechanical Specification

Weight including batteries	: 9 Kg
Weight excluding batteries	: 4 Kg
Dimensions (Standard batteries)	: 395mm(L) x 270mm(H) x 115mm(D)
Type of Material (backbox)	: Mild Steel (Power Coated)
Type of Material (Facia)	: PC/ABS
Flammability Rating	: UL 94 V0
Total Number of knockouts	: 11
Diameter of Knock out	: 20mm

TERMINAL BLOCKS : DO NOT USE EXCESSIVE FORCE WHEN TIGHTENING THE SCREWS ON THE TERMINAL BLOCK

Cable & Wiring

Only the cable types listed below are allowable for loop connections.

DRAKA Cables (Part Number 910234) Technical Specification



Cabling Application		Applicable Standards	
Circuit integrity Structured Wiring		ISO/IEC 11801:95	
Alarm/Lighting Cable Part Number 910234		EN 50173:95	
Patent Protected Design		Fire Propagation Test : UL 1581 VW1; IEC60332.3;	
		Cct Integrity tests: IEC 60331; BS5839: 2002	
Cable construction			
Conductor	Bare Cu Wire	Outside Diameter of Conductor	0.65 mm
Insulator Material		Outside Diameter of Insulation	1.70 mm
Number of Twisted Pairs	PE/Sil Rbr	Outside Diameter of Sheath	5.3 mm
Glass Tape	1	Weight OHLS	15.8 kg/km
Screen Material	Mica	Sheath Colour (OEM Specified)	Various
Braid	Ali/Mylar	Sheath Printing (up to 24 characters)	Batch No. & Metre marking
Sheath Material	TCWB OHLS		
Cable Properties		Electrical Characteristics @ 20 °C	
Min. Installation Bend Radius	8 x Dia	Return Loss RI	>IEC dB
Min. Installed Bending Radius	4 x Dia	Characteristic impedance @ 10MHz	100±5Ω
Max. Installation Tension	50N	DC Conductor Loop Resistance	30 Ω/100m
Max. Installed Tension	Zero	Max. Resistance unbalance	?2%
InstTemp. Range Installed	0 to 0°C	Nominal Velocity of Propagation	57%
Operating Temp. Range	-20 to 60°C	Insulation Resistance (500V 300/500v rated)	?5000 MΩ.km
Fire tests BS 5839: 2002 & IEC60331			
Continued Data Operation @ 950	>3 Hours		
Smoke test	passed		
Approvals	passed		

When choosing your preferred cable type, you must take note of the following cable and wiring requirements.

1. The cable must be 2 core screened with an over sheath.
2. Maximum loop length with any of the above cables is 1KM
3. Multicore cable should not be used for detector wiring.
4. The screen or drain wire of the network cable should not be considered as a safety earth.
5. Screen continuity must be maintained throughout the entire network circuit including at each junction point.
6. Where the network cable passes between buildings, screen continuity should not be maintained from building to building. A booster device must however be used irrespective of cable length and should be fitted at a suitable point in the link between buildings. The cable screen should be connected to the earth of one panel in each building.

Installation

The panel should be installed in a clean, dry, reasonably well ventilated place, and not in direct sunlight. Temperatures in excess of +45°C and below -10°C may cause problems, if in doubt consult [Technical Support](#). The panel should be located away from any potential hazard, in a position where it is readily accessible to authorised staff, and the fire services, ideally on the perimeter of a building near a permanent entrance. Mount the panel to the wall using the drill template provided. Do not drill through the panel to the wall as dust will contaminate the circuitry.

Installation Guide

- Never carry out insulation tests on cables connected to electronic equipment.
- **DO NOT OVER TIGHTEN TERMINAL CONNECTOR SCREWS**
- Always use the correct type of cables specifically designed for the operation of fire detection and alarm circuits.
- Always adhere to volt drop limitation when sizing cables
- Always observe polarity throughout. Non colour coded conductors should be permanently identified.
- Screen continuity must be maintained throughout the entire network.
- The screen should be earthed at the connection point provided at the Panel and not at any other point.

Care must be taken to avoid connecting the screen to the earthed body of any metal devices, enclosures or cable containment. The screen or drain wire of the network cables should not be considered as safety earth and therefore should not be connected to terminals marked with the earth symbol, except at the panel, and should not be insulated with green and yellow sleeving.

Fixing details

Read all the installation instructions before commencing with the installation. The installation of this panel must be carried out by a suitably qualified /trained person. The installation must comply with IEE wiring regulations and with BS5839 part 1 2002

The electronic components within the fire panel are Static Sensitive. Do not touch the electronics directly.

Mounting the Backbox

The Panel can be surface mounted and recessed . To surface mount; drill three holes and fix the backbox to the wall using suitable screw fixings.

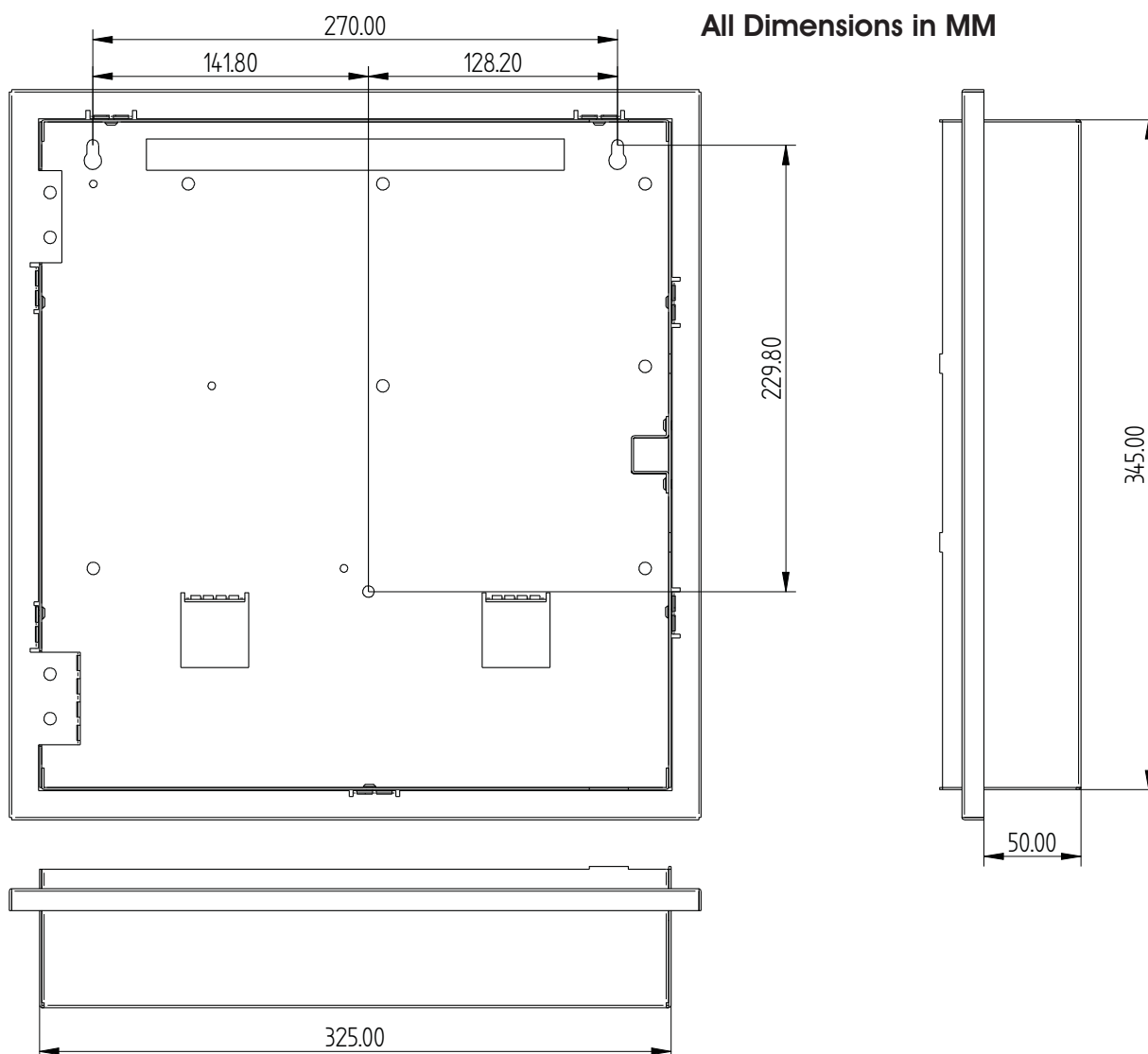

Installing Cabling

Once the backbox is mounted the next stage is to install the power and loop cables and fit the glands.

External Connections

Mains Supply

The mains supply should be installed in accordance with the current edition of the IEE wiring regulations. Connection to the mains supply must be via an isolating device (e.g. an isolating fuse) reserved solely for the fire alarm system. The cover should be coloured red and labelled "FIRE ALARM - DO NOT SWITCH OFF". The isolating protective device should be secure from unauthorised operation and ideally installed in a securely closed box with a breakable cover.

An additional warning label should be provided, depending on whether:-

a) The isolating protective device is fed from the live side of the main isolating device in which case the label on the isolating protective device, should read in addition - "WARNING: THIS SUPPLY REMAINS ALIVE WHEN THE MAIN SWITCH IS TURNED OFF". A further label should be placed on the main isolating device reading "WARNING: THE FIRE ALARM SUPPLY REMAINS LIVE WHEN THIS SWITCH IS TURNED OFF.

Or

b) If the isolating protective device is fed from the dead side of the main isolating device, a label should be fixed to the main isolating device reading "WARNING: THIS SWITCH ALSO CONTROLS THE SUPPLY TO THE FIRE ALARM SYSTEM".

Distributed Power Supplies

The above also applies to any distributed power supply (i.e. mains connections for Repeater Panels , Sounders Controller Units, etc.)

Networking

Up to One Hundred & Twenty Six Panels or repeaters can be networked together to operate as a single networked system. To achieve this each panel must be fitted with a network card (Optional Extra)

When operating as a networked system all fire and fault event information is displayed at every panel, silencing and resetting of alarms can also be carried out from any panel on a networked system if panels are suitably configured.

Networked panels are connected using a loop topology as illustrated.

Networked panels can be used as active repeaters, alternatively a low cost passive repeater is available.

This can either be connected a loop of an individual panel or it can be connected to the network.

The recommended network cable for the network connection between panels is an enhanced Firetuf cable Manufactured by Draka cables (part number 910234.)

Screen continuity must be maintained throughout the entire network circuit including at each junction point. The screen should only be earthed at the connection point provided at the first panel and not at any other point. The screen or drain wire of the network cable should not be considered as a safety earth and therefore should not be connected to terminals marked with the earth symbol, except at the panel, and should not be insulated with green and yellow sleeving

Where the network cable passes between buildings, screen continuity should not be maintained from building to building. A booster device must however be used irrespective of cable length and should be fitted at a suitable point in the link between buildings. The cable screen should be connected to the earth of one panel in each building. 102 Ω terminator should be fitted at the beginning and the end of the network. If the distance in the network exceeds 1KM the booster should be used. The booster requires 24V local supply, which can be connected to nearest Addressable Panel

4.1.3 Acceptable Cable length.

Based on the above cable, the maximum acceptable length between signal boosters is 1000 Metres. This distance can only be achieved when the above cable is used, Cooper lighting and security does not recommend the use of other network cables.

Once the maximum cable length has been reached, a booster must be fitted which then allows a further length of the same distance (1000 Metres for the recommended cable).

A maximum of 5 network boosters can be used

N.B. Repeater control panels do not act as boosters, therefore the location of such panels is irrelevant when calculating cable lengths and the requirement for booster devices.

For convenience when using 24V boosters (see following) it may be desirable to house the booster near to an repeater control panel to derive a convenient power supply.

Networking

Please Note: Cooper Network cards are fitted with loop terminators as standard please cut if not required.

Daisy chain configuration Single Network Card

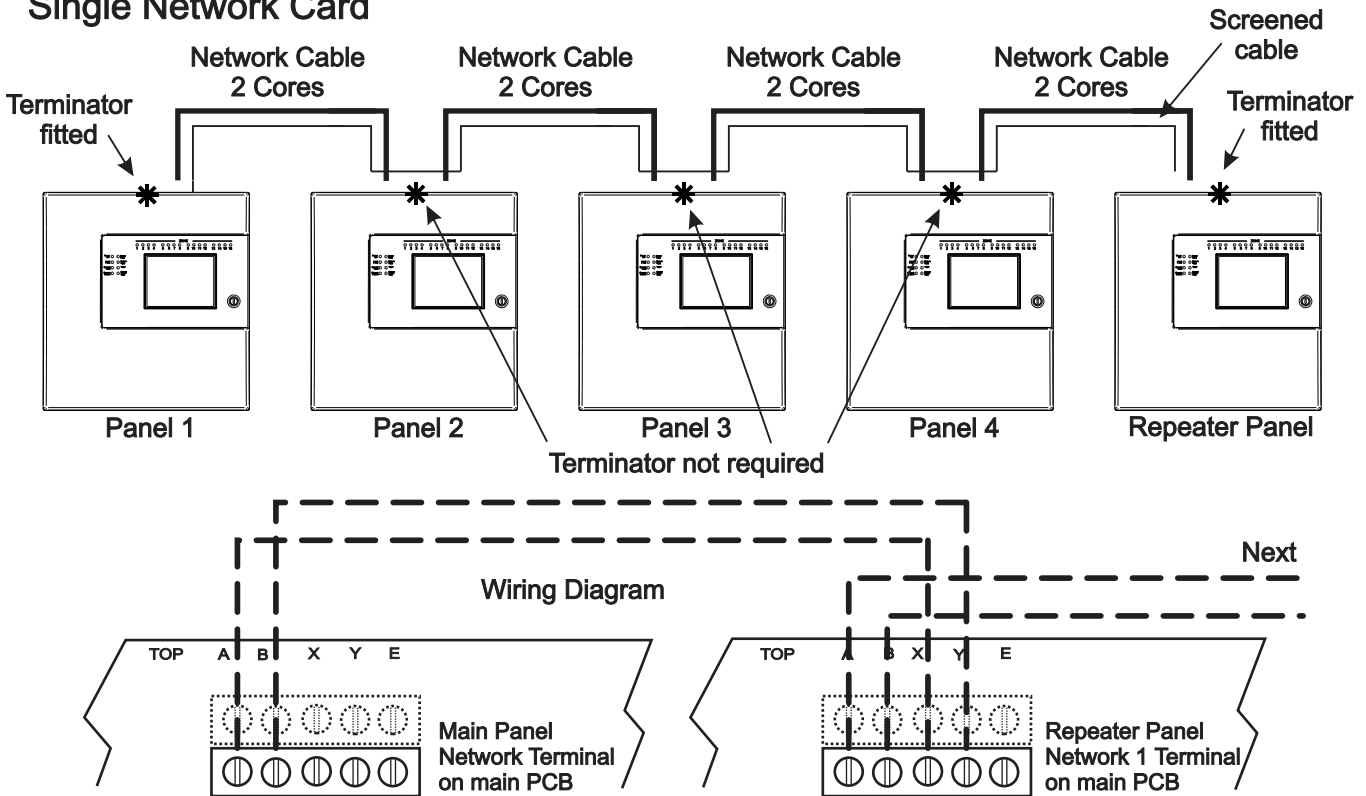

Redundant Network

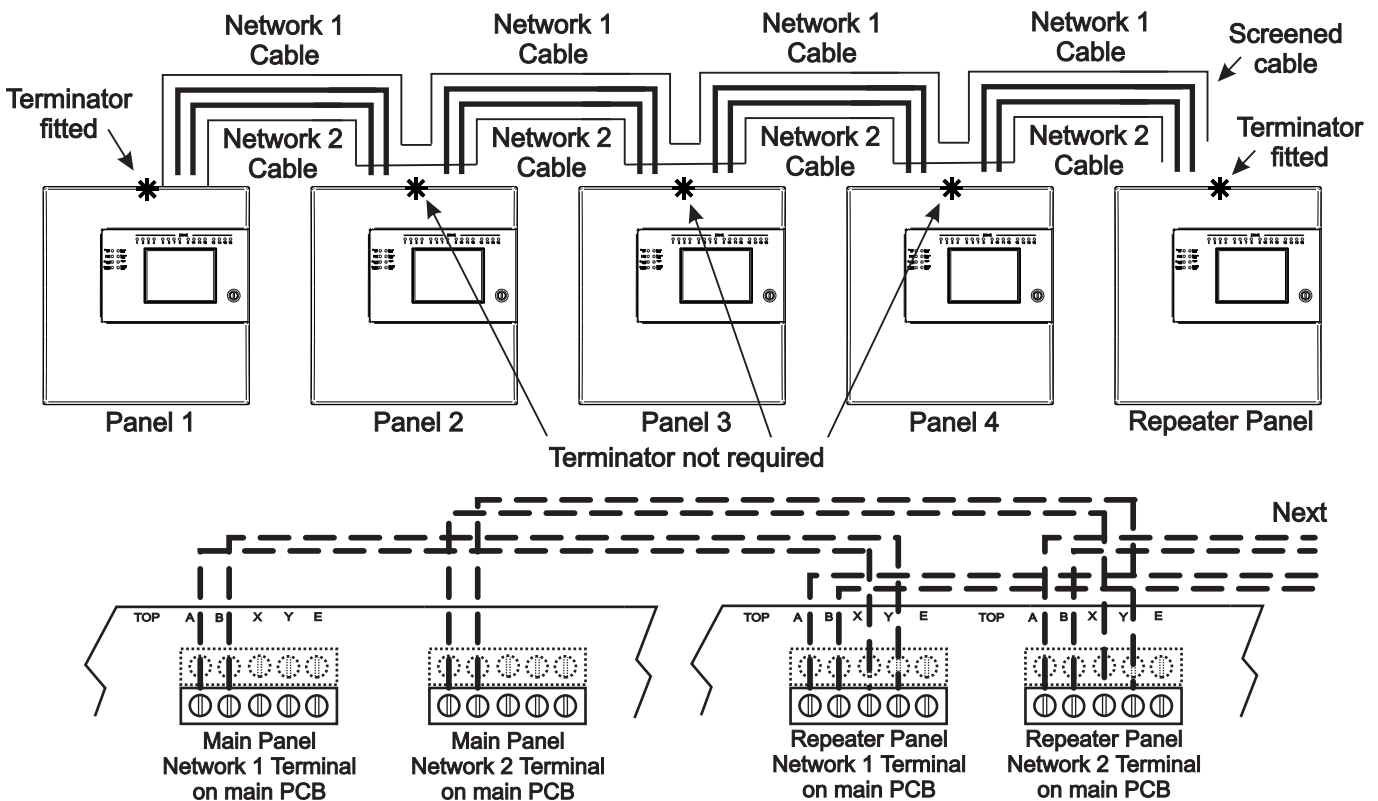

Section 2

Commissioning

Commissioning

The Cooper Repeater is a plug & play technology where downloading of text information through a PC is not required as the text information is downloaded via the network.

1. Supply the network address (pagexxxxxxxxxxx)
2. Select the repeater mode information (page xxxxxxxx)
3. Program the relays output and programable input if required (page xxxxxxxxxxxxxxxxxxxxx)
4. Select the power supply option (page xxxxxxxxx)

Section 3

Panel Controls & Indicators

Panel Controls & Indicators

1. System LED's
2. Zonal LED's
3. Touch Screen Display

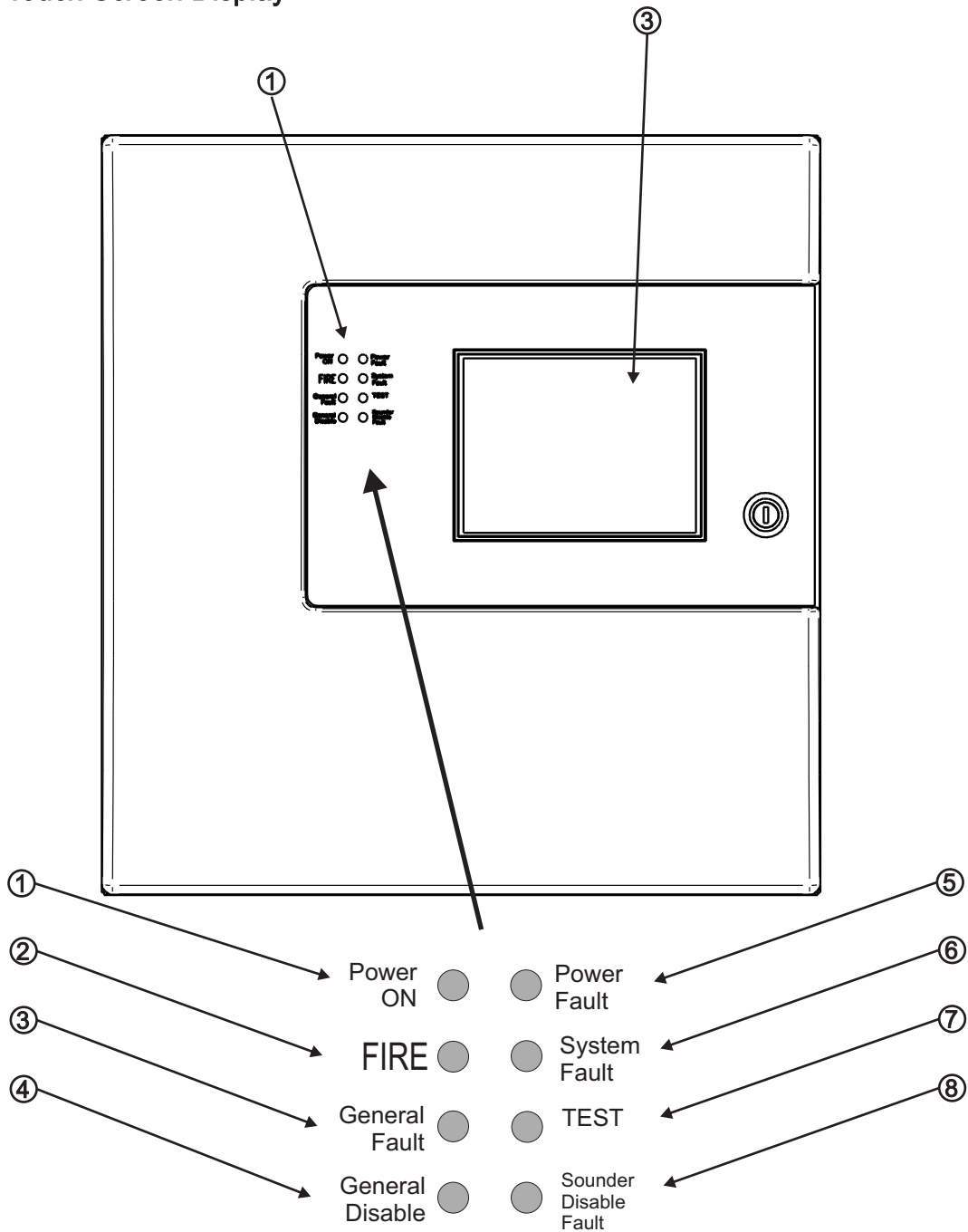

LED	Name	Function	Action
1	Power On	Shows Panel is On	Check Indicator is Illuminated
2	Fire	Indicators Panel has Detected a Fire	Impliment Fire Action Procedure
3	General Fault	Monitors Devices for Faults e.g. Smoke detectors/Sounders	Report to System Supervisor
4	General Disable	Monitors Fire Panel for Faults	Report Fault to Service Dept
5	Power Fault	Monitor Internal Battery Charger	Report Fault to Service Dept
6	System Fault	Monitors Fire Panel for Faults	Report Fault to Service Dept
7	Test	Supervisor/Engineer is Testing the Systems	Report to System Supervisor
8	Sounder	Indicates the Sounder Status	Check with System Supervisor

Touch Screen Display

Supervisor	Fires 0	Pre Alarms 0	Faults 0	Disabled 0
Repeater Panel System Healthy				
Tuesday dd-mm-yyyy				
16:25.25 BST On				

The Touch Screen is a multi-function display consisting 320x240 dots featuring high intensity backlighting. In normal operation, the display indicates as above with the backlighting off.

During an event on the system the display shows the FIRST EVENT and LAST EVENT plus other events as space allows.

The last 2 lines are normally used to display the total number of events, but they are also used for scrolling fire conditions, faults, pre alarms or disabled devices independently or for displaying a reduced menu when in fire condition.

When an event occurs the Touch Screen backlighting comes on unless there is a mains power supply fault.

Use the Touch Screen to scroll through all active events on the system by using the SCROLL UP and SCROLL DOWN buttons (available at access level 1). You can display the contents of the log and also view details of any fires, faults, pre-alarms, faults or disablements.. When displaying the system menu on the Touch Screen, the last 5 lines of the display are shown in reverse text.

Panel Operation

The Panel is operated via a backlit touch screen. The default fire screen is shown below. From this screen all the panels functions can be operated. The first time you touch the screen the backlight will illuminate the panel.

Supervisor	Fires 0	Pre Alarms 0	Faults 0	Disabled 0
Repeater Panel System Healthy				
Tuesday dd-mm-yyyy				
16:25.25 BST On				

Pressing a field will highlight it and forward to the next screen as shown below.

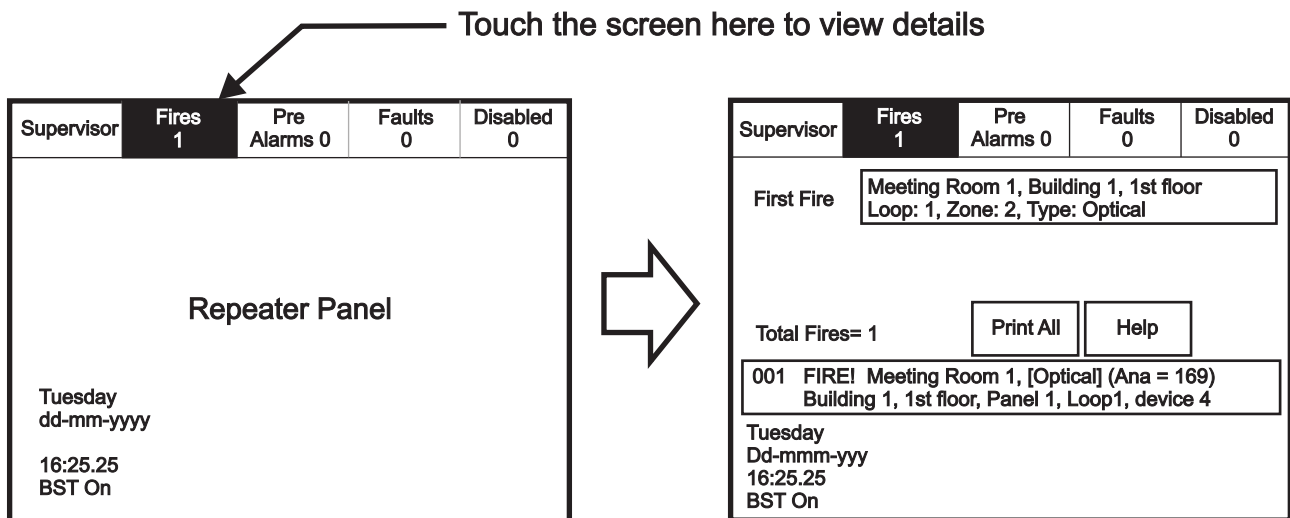

Public Access Level 1

Public access level does not require an access code and allows anybody to review the functions outlined below.

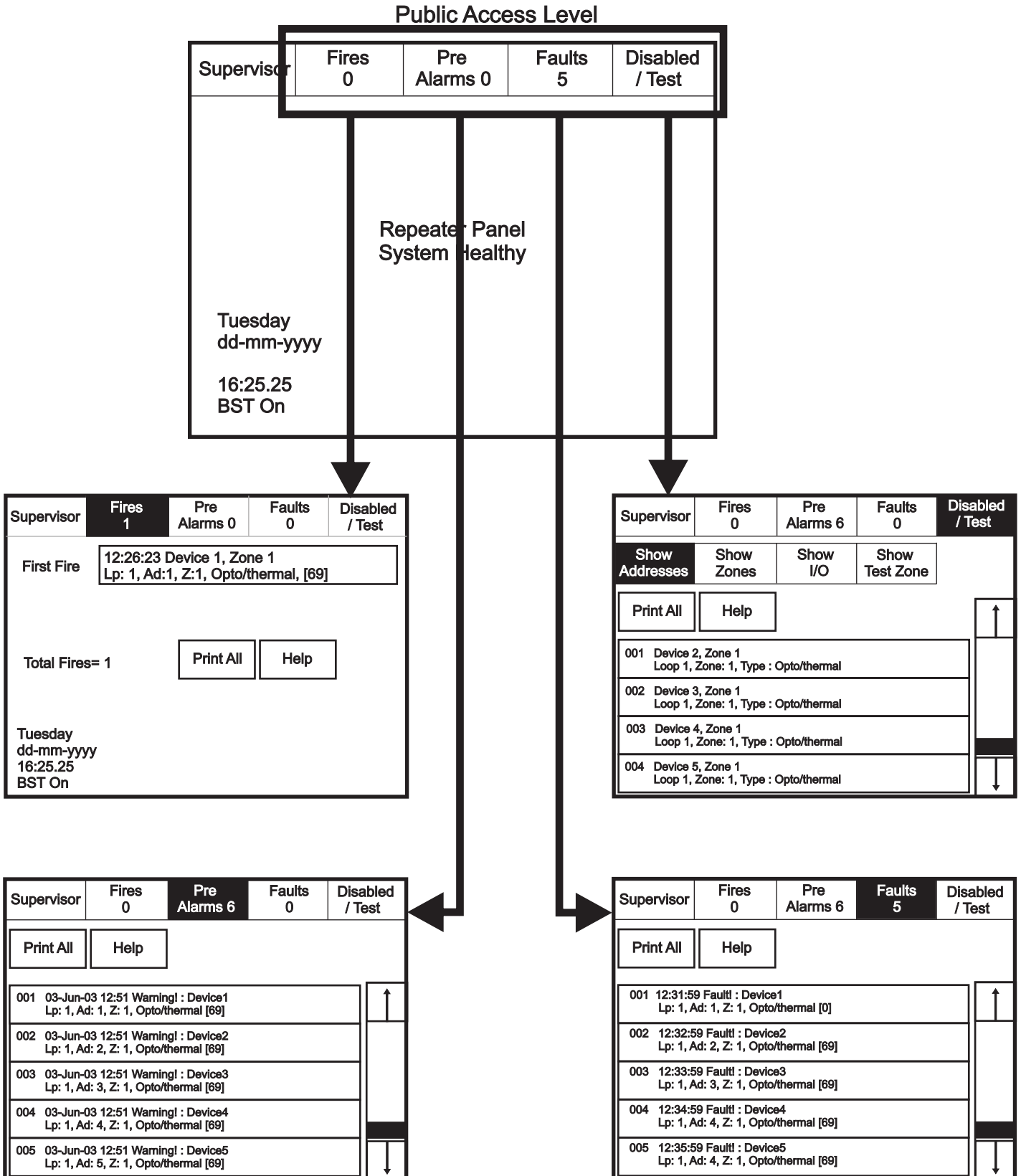

Evacuate (Access Level 2)

To activate the touch screen, touch the top left corner of the screen until the screen illuminates. To enter the supervisor mode touch the supervisor button and enter the passcode.

Enter the Supervisor Mode Passcode and select "Evacuate" on the menu at the top of the screen.

Supervisor	Evacuate	Silence Alarms	Mute Buzzer	Reset
View Fires AC = 0	View Pre Alarms	Disabled	Faults	Others
<p>Pre-alarm = Some smoke/heat but below fire threshold. Disabled = Detectors, alarms etc that are switched off. Faults = Short circuits, broken detectors etc. Others = Enabled/Disabled, printing log, tests etc.</p> <p>To silence all alarms, touch "Silence Alarms" To activate all alarms, touch "evacuate".</p>				

Select "Yes" to evacuate the building.

**This will activate ALL sounders
and activate all panel relays
Do you wish to continue?**

Yes

No

Silence Alarms

To activate the touch screen, touch the top left corner of the screen until the screen illuminates. To enter the supervisor mode touch the supervisor button and enter the passcode.

Enter the Supervisor Mode Passcode and select "Silence Alarms" button as the top of the screen.

Supervisor	Evacuate	Silence Alarms	Mute Buzzer	Reset
View Fires AC = 0	View Pre Alarms	Disabled	Faults	Others
<p>Pre-alarm = Some smoke/heat but below fire threshold. Disabled = Detectors, alarms etc that are switched off. Faults = Short circuits, broken detectors etc. Others = Enabled/Disabled, printing log, tests etc.</p> <p>To silence all alarms, touch "Silence Alarms" To activate all alarms, touch "evacuate".</p>				

Select "yes" to silence Alarm.

**This will silence ALL sounders
Do you wish to continue?**

Yes

No

Mute Buzzer

To activate the touch screen, touch the top left corner of the screen until the screen illuminates. To enter the supervisor mode touch the supervisor button and enter the passcode.

Enter the Supervisor Mode and Select “Mute Buzzer” from the Top Menu

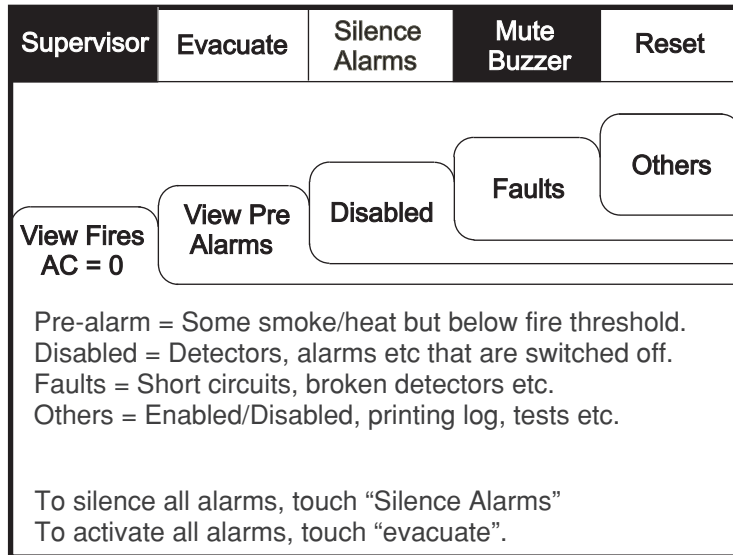

Reset

Enter the Supervisor Mode and Select “Reset” from the top Menu. Select “Yes” to reset the panel.

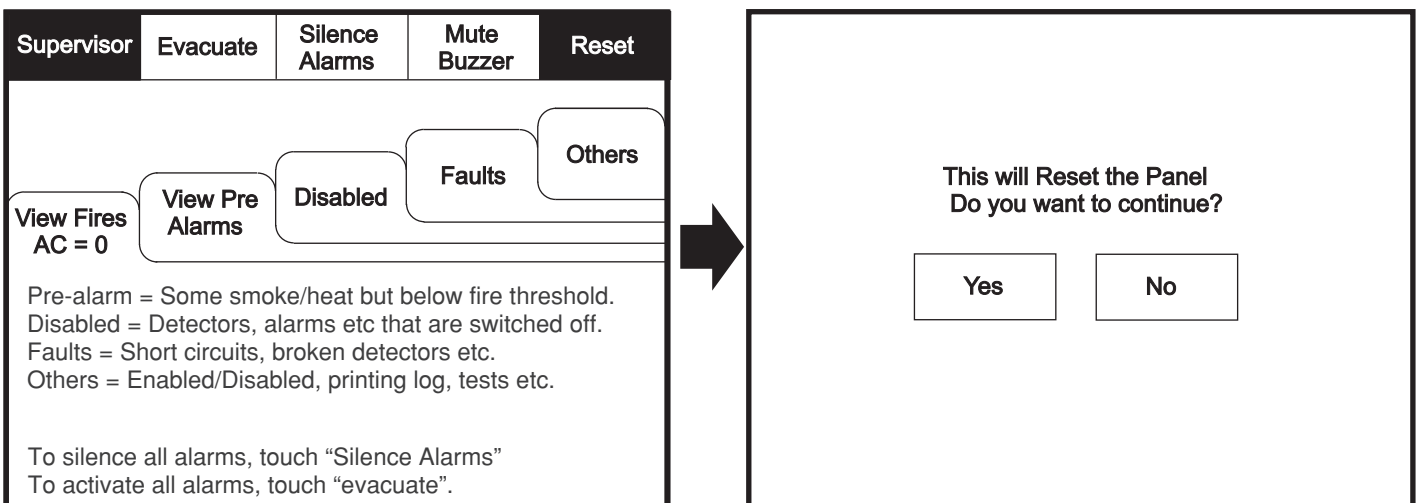

Pre-Alarms

Enter the Supervisor Mode and Select "Pre-Alarms" tab.

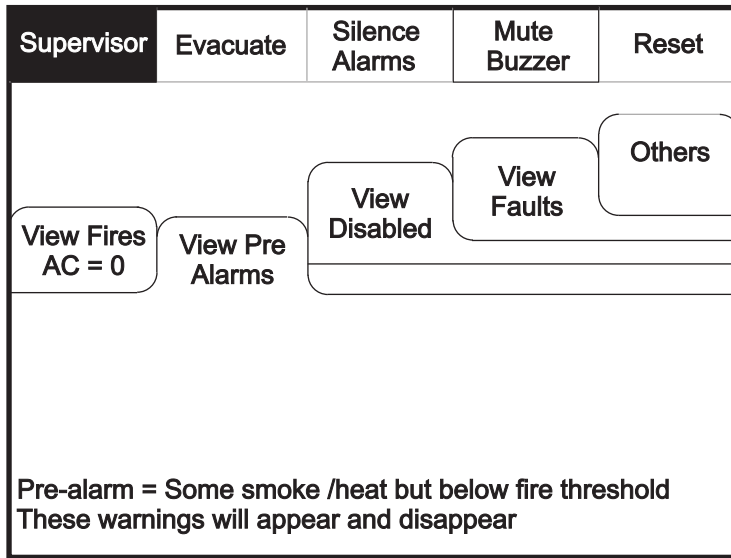

A pre-alarm is shown when a detector appears to register heat or smoke but in a quantity that is insufficient to warrant an alarm. Pre-alarm may indicate a build up of dirt in a smoke detector which can be interpreted by the detector as smoke presence.

Disabled Devices

Enter the Supervisor mode and Select the "Disabled" tab.

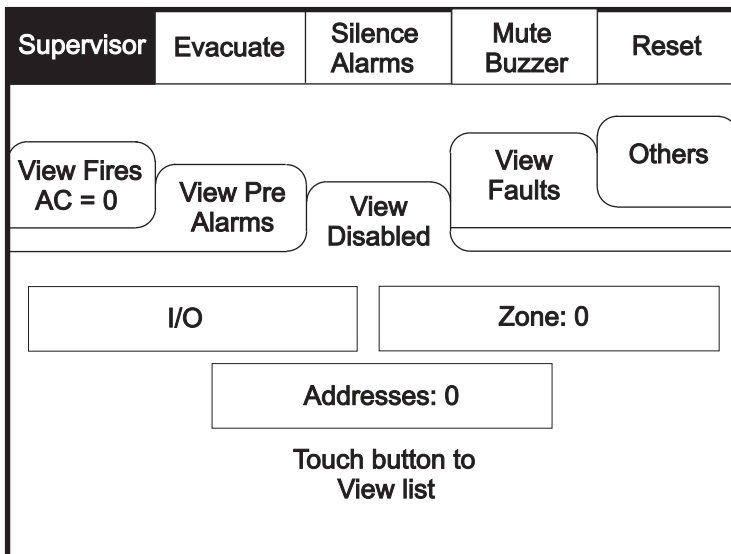

The individual buttons show which devices and the number of devices which have been disabled. Press one of the buttons to display detailed information for a particular category

Faults

Enter Supervisor Mode Passcode and select “Faults” tab.

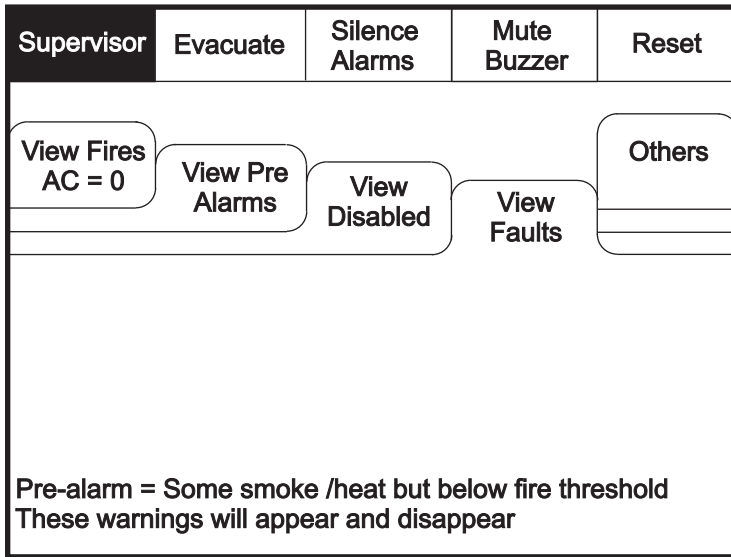

Enable/Disable (others Menu)

To activate the touch screen, touch the top left corner of the screen until the screen illuminates. To enter the supervisor mode touch the supervisor button and enter the passcode.

Enter the Supervisor Mode passcode and select the “Others” tab.

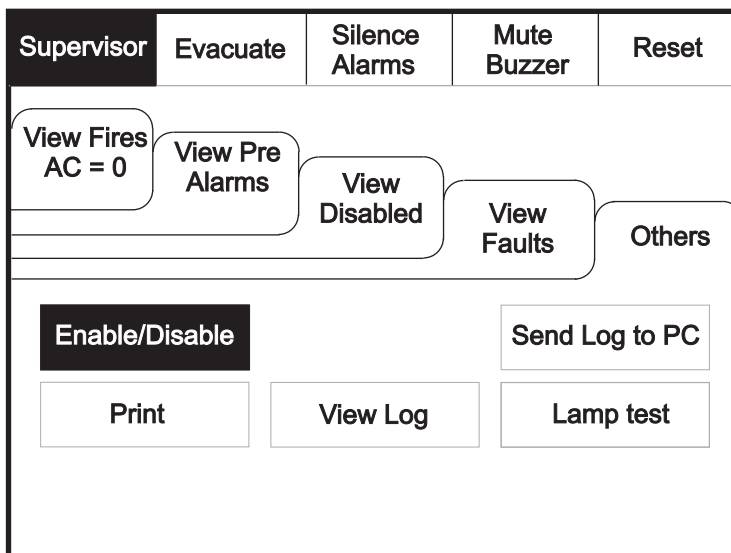

Enable/Disable

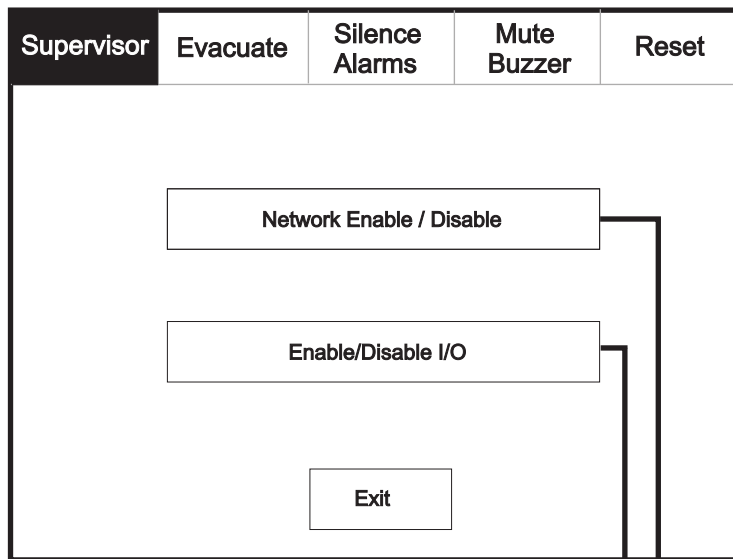

The Enable/Disable feature allows the operator to disable part or a whole system by the sub menus shown on the left.

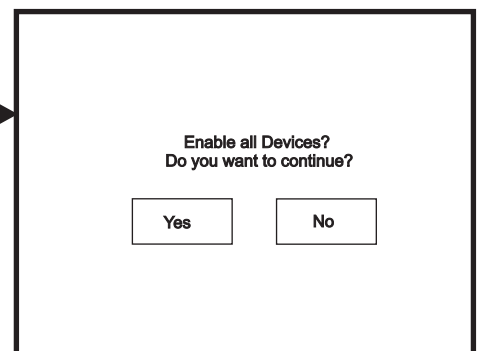
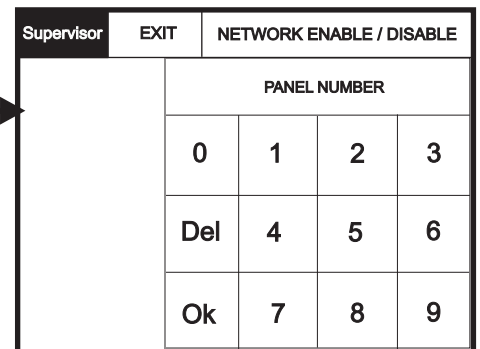

Print (function not available)

To activate the touch screen, touch the top left corner of the screen until the screen illuminates. To enter the supervisor mode touch the supervisor button and enter the passcode.

Enter the Supervisor Mode and Select the "Others" Tab. Press "Print"

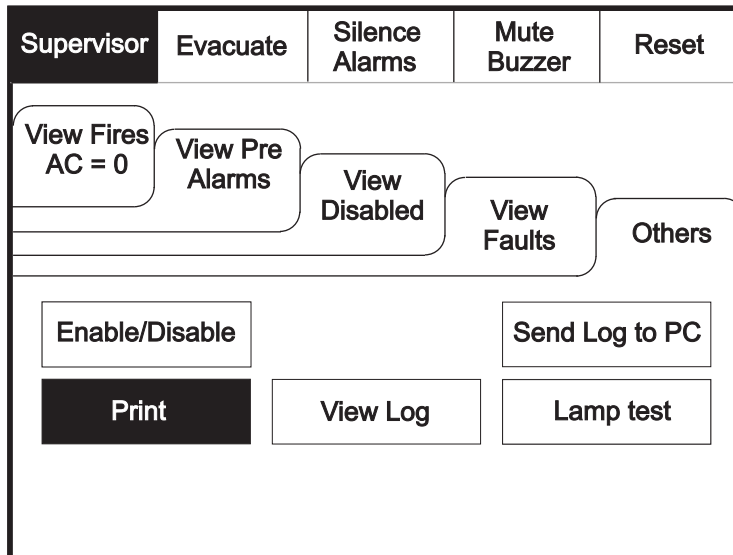

Select the Information You wish to Print from the Buttons Listed.

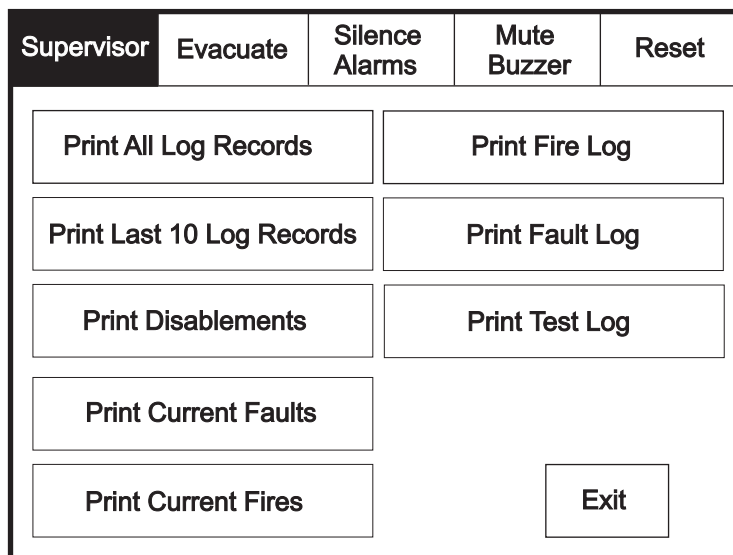

Lamp Test

To activate the touch screen, touch the top left corner of the screen until the screen illuminates. To enter the supervisor mode touch the supervisor button and enter the passcode.

Enter the Supervisor Mode and Select the “Others” Tab. Press “Lamp Test”

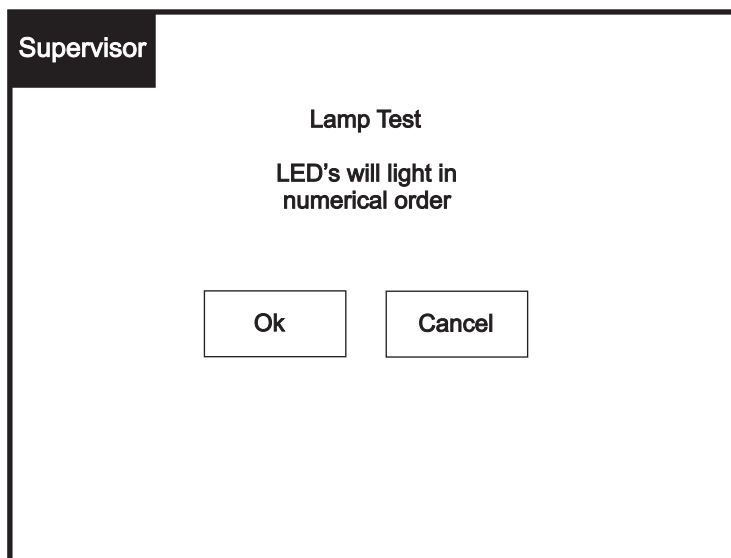
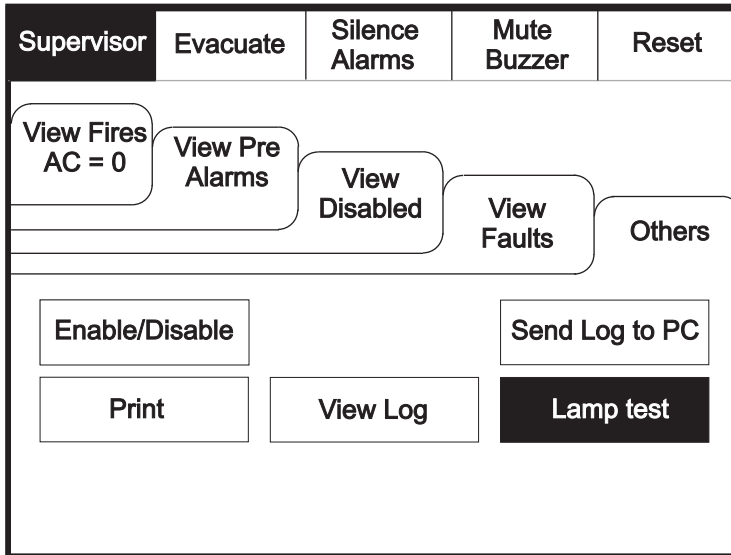

Viewing Events

To activate the touch screen, touch the top left corner of the screen until the screen illuminates. To enter the supervisor mode touch the supervisor button and enter the passcode.

Enter the Supervisor Mode Passcode. Select the "Others" tab and press View Log.

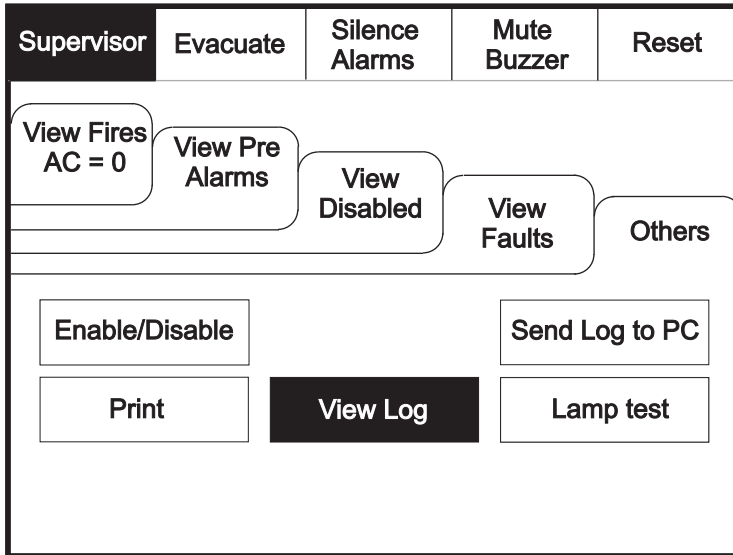

Use the scroll bar to view the list of upto 1000 events.

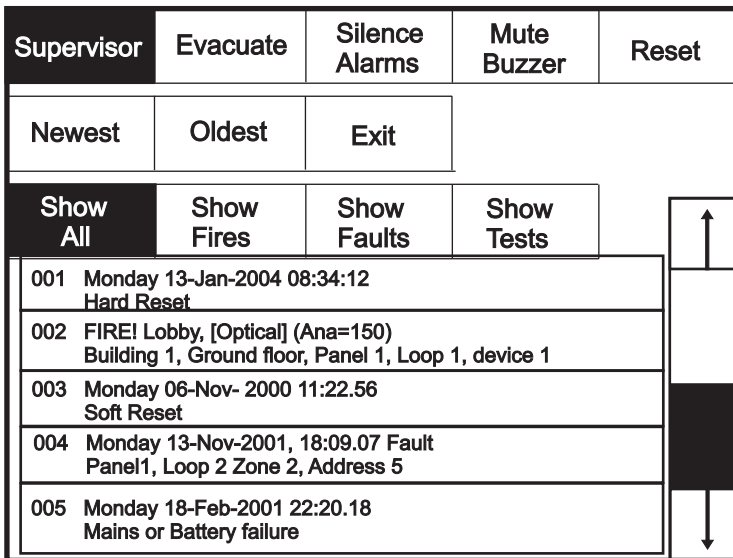

Events can be sorted by selecting from the sort option menu.

The Panel event log stores up to 1000 events including, fires, faults, resets and address changes. Once the maximum 1000 events has been reached Panel will automatically overwrite the oldest event every time a new event is stored. The event log can only be reset by an approved service engineer.

Send Log to PC

To activate the touch screen, touch the top left corner of the screen until the screen illuminates. To enter the supervisor mode touch the supervisor button and enter the passcode.

Enter the Supervisor Mode and Select the "Others" Tab. Press Send Log to PC.

XX

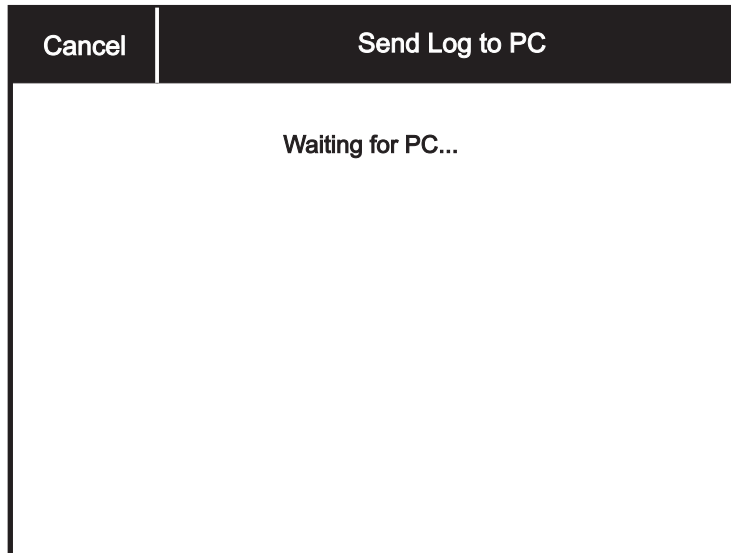
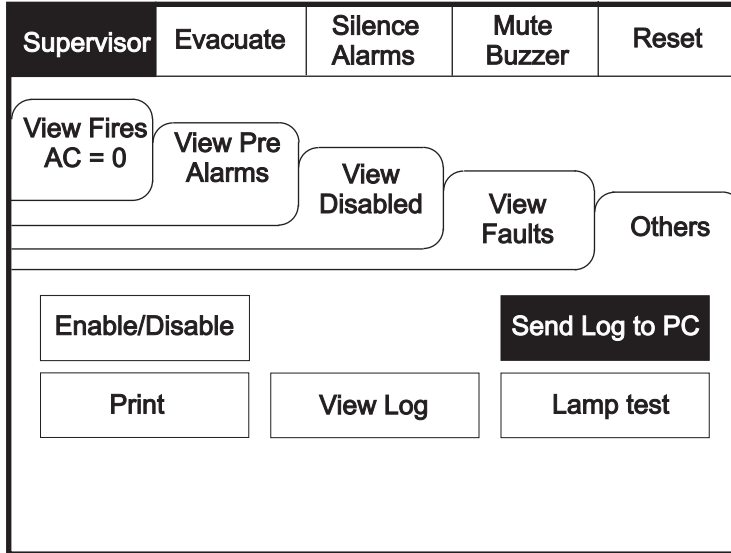

Erase Log

To activate the touch screen, touch the top left corner of the screen until the screen illuminates. To enter the supervisor mode touch the supervisor button and enter the service passcode.

Enter the Service Mode and Select Commission.

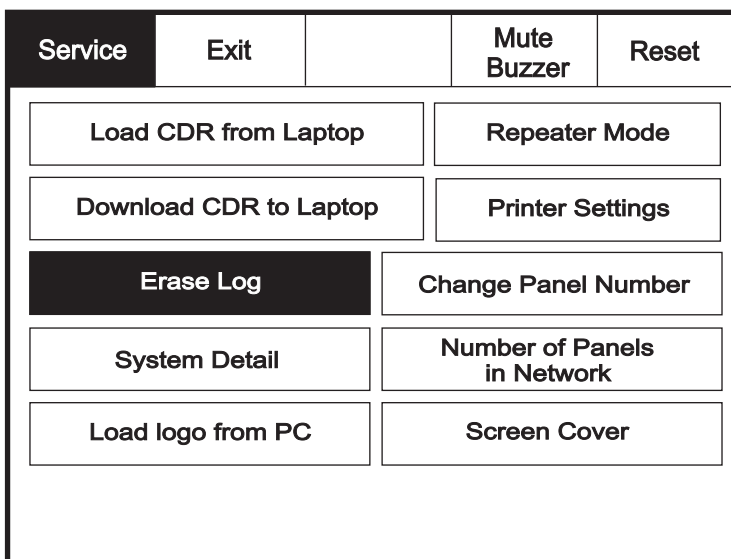
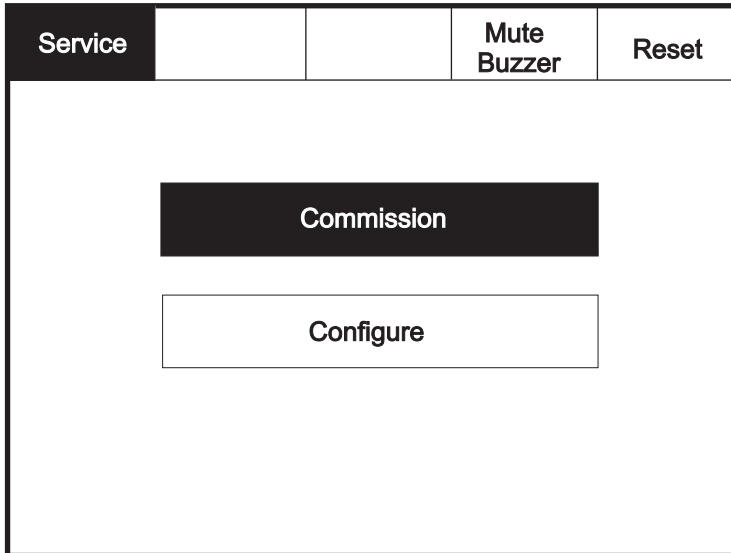

Select "Erase Log and Reset" from the Configure Menu Screen.



System Details

To activate the touch screen, touch the top left corner of the screen until the screen illuminates. To enter the supervisor mode touch the supervisor button and enter the service passcode.

Enter the Service Mode and Select Commission, then Press "System Details".

Service			Mute Buzzer	Reset
<div style="background-color: black; color: white; padding: 10px; margin: 10px auto; width: 80%;">Commission</div> <div style="border: 1px solid black; padding: 10px; margin: 10px auto; width: 80%;">Configure</div>				

Service	Exit		Mute Buzzer	Reset
Load CDR from Laptop		Repeater Mode		
Download CDR to Laptop		Printer Settings		
Erase Log		Change Panel Number		
System Detail		Number of Panels in Network		
Load logo from PC		Screen Cover		

Service FRE off	Print	Exit		Reset
Program		V0.00.15		
Program Data		09-Mar-2004		
Program Checksum		0xAA95524		
CDR		V0.5		
CDR Checksum		0xF7D95E		
Loop Controller 1		V0.0.0		
Loop Controller 2		V0.0.0		
Panel Number		0		
Total Panels		1		
Total Zones		4		

Load Logo from PC

To activate the touch screen, touch the top left corner of the screen until the screen illuminates. To enter the supervisor mode touch the supervisor button and enter the service passcode.

Enter the Service Mode and Select Commission.

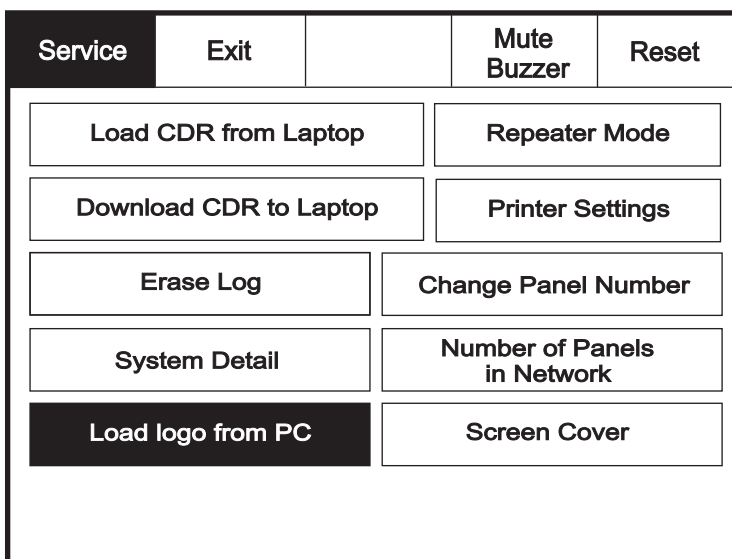
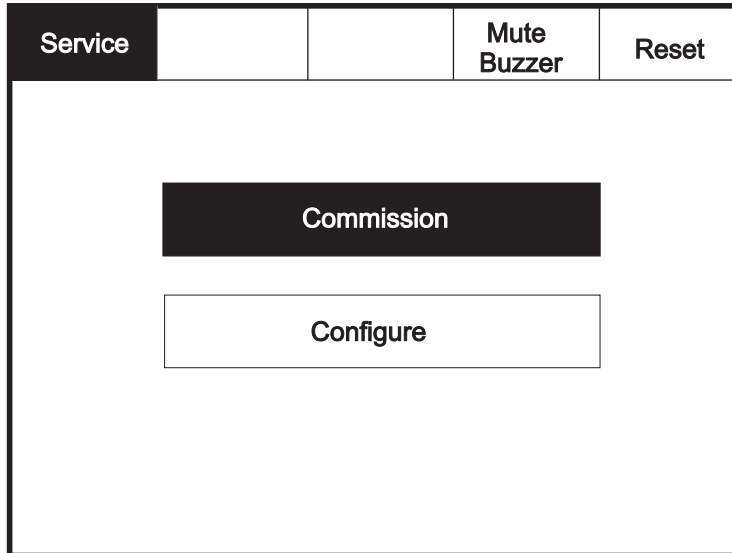

Select "Load logo from PC" from the Configure Menu Screen.

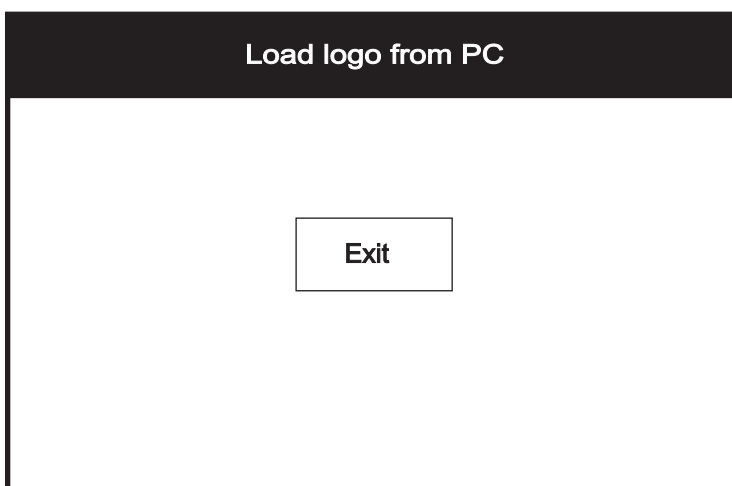

Repeater Mode

The Repeater can be set as active or passive. Unlike the active repeater, the passive repeater will only display information, no action from the repeater is transferred to the network.

Enter the Service Mode and Select Commission.

Service			Mute Buzzer	Reset
<div style="background-color: black; color: white; padding: 5px; margin: 10px auto; width: 80%;">Commission</div> <div style="border: 1px solid black; padding: 5px; margin: 10px auto; width: 80%;">Configure</div>				

Service	Exit		Mute Buzzer	Reset
Load CDR from Laptop		Repeater Mode		
Download CDR to Laptop		Printer Settings		
Erase Log		Change Panel Number		
System Detail		Number of Panels in Network		
Load logo from PC		Screen Cover		

Press "Repeater Mode"

Service	Exit			Reset
<div style="background-color: black; color: white; padding: 5px; margin: 10px auto; width: 80%;">Active</div> <div style="border: 1px solid black; padding: 5px; margin: 10px auto; width: 80%;">Passive</div>				

Select "Active" for an active repeater or "Passive" for a passive repeater

Printer Settings

To activate the touch screen, touch the top left corner of the screen until the screen illuminates. To enter the supervisor mode touch the supervisor button and enter the service passcode.

Enter the Service Mode and Select Commission then press "Printer settings".

Service			Mute Buzzer	Reset
<div style="background-color: black; color: white; padding: 10px; margin: 10px auto; width: 80%;">Commission</div> <div style="border: 1px solid black; padding: 10px; margin: 10px auto; width: 80%;">Configure</div>				

Service	Exit		Mute Buzzer	Reset
Load CDR from Laptop		Repeater Mode		
Download CDR to Laptop		Printer Settings		
Erase Log		Change Panel Number		
System Detail		Number of Panels in Network		
Load logo from PC		Screen Cover		

Service	Exit			Reset
<div style="background-color: black; color: white; padding: 10px; margin: 10px auto; width: 80%;">Auto</div> <div style="border: 1px solid black; padding: 10px; margin: 10px auto; width: 80%;">Request</div>				

Change Panel Number

To activate the touch screen, touch the top left corner of the screen until the screen illuminates. To enter the supervisor mode touch the supervisor button and enter the service passcode.

Enter the Service Mode and Select Commission then press “Change Panel Number”

Service			Mute Buzzer	Reset
<div style="border: 1px solid black; width: 100px; height: 20px; margin: 10px auto; background-color: black; color: white; display: flex; align-items: center; justify-content: center;">Commission</div> <div style="border: 1px solid black; width: 100px; height: 20px; margin: 10px auto; display: flex; align-items: center; justify-content: center;">Configure</div>				

Service	Exit		Mute Buzzer	Reset
Load CDR from Laptop		Repeater Mode		
Download CDR to Laptop		Printer Settings		
Erase Log	Change Panel Number			
System Detail	Number of Panels in Network			
Load logo from PC	Screen Cover			

Change Panel Number 0 <div style="border: 1px solid black; width: 50px; height: 20px; margin: 10px auto; display: flex; align-items: center; justify-content: center;">Cancel</div>	1	2	3
	4	5	6
	7	8	9
	ok	0	←

Number of Panels in Network

To activate the touch screen, touch the top left corner of the screen until the screen illuminates. To enter the supervisor mode touch the supervisor button and enter the service passcode.

Enter the Service Mode and Select Commission then press “Number of Panels in

Service			Mute Buzzer	Reset
<div style="border: 1px solid black; width: 100px; height: 20px; margin: 10px auto; background-color: black; color: white; display: flex; align-items: center; justify-content: center;">Commission</div> <div style="border: 1px solid black; width: 100px; height: 20px; margin: 10px auto; display: flex; align-items: center; justify-content: center;">Configure</div>				

Service	Exit		Mute Buzzer	Reset
Load CDR from Laptop		Repeater Mode		
Download CDR to Laptop		Printer Settings		
Erase Log		Change Panel Number		
System Detail		Number of Panels in Network		
Load logo from PC		Screen Cover		

Change Panel Number 0 <div style="border: 1px solid black; width: 50px; height: 20px; margin: 5px auto; display: flex; align-items: center; justify-content: center;">Cancel</div>	1	2	3
	4	5	6
	7	8	9
	ok	0	←

Change Date/Time

Enter the Service Mode and Select Configure. Select Change Date/Time.

Service			Mute Buzzer	Reset
<div style="border: 1px solid black; width: 200px; margin: 10px auto; padding: 5px;">Commission</div> <div style="background-color: black; color: white; width: 200px; margin: 10px auto; padding: 5px; text-align: center;">Configure</div>				

Service	Exit		Mute Buzzer	Reset
Change Date/Time		Add/Delete Zone		
Change Password		Network		
Relay Control		Language		
Programmable Input		Network Protocol		
		Power Supply		

Set the Time Using the Buttons Shown Below.

Service	Ok	Cancel		Reset
Current Time:		+1 Hour	+10 Mins	+1 Mins
10:16:12		-1 Hour	-10 Mins	-1 Mins
BST On		+1 Day	+1 Month	+1 Year
Current Date:		-1 Day	-1 Month	-1 Year
Wednesday dd-mmm-yyyy				

Change Panel Text

Enter the Service Mode and Select Configure. Select "Change Text"

Service	Exit		Mute Buzzer	Reset
Change Date/Time			Add/Delete Zone	
Change Text			Network	
Configure Zones			Language	
Change Password			Network Protocol	
Relay Control			Power Supply	
Programmable Input				

Press "Change Panel Text"

Service	Exit		Mute Buzzer	Reset
<div style="border: 1px solid black; padding: 10px; width: fit-content; margin: 0 auto;">Change Panel Text</div>				

Correct Panel Text									
CF1100.....									←
1	2	3	4	5	6	7	8	9	0
Q	W	E	R	T	Y	U	I	O	P
	A	S	D	F	G	H	J	K	L
CAPS	Z	X	C	V	B	N	M	,	.
OTHER		SPACE			OK		CANCEL		

Change Passcode

Enter the Service Mode and Select Configure. Select "Change User Code"

Service	Exit		Mute Buzzer	Reset
Change Date/Time	Add/Delete Zone			
Change Text	Network			
Configure Zones	Language			
Change Password	Network Protocol			
Relay Control	Power Supply			
Programmable Input				



Please enter Passcode:	1	2	3
.....			
New Code:	4	5	6
.....			
Verify New Code:	7	8	9
.....			
<input type="button" value="Cancel"/>	ok	0	←

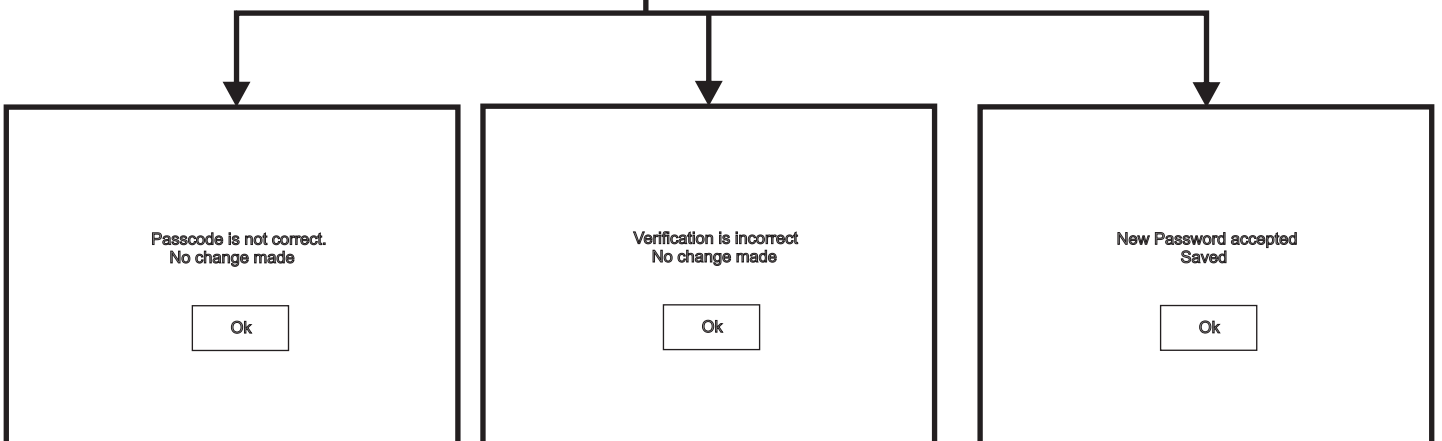

Relay Control

The repeater is equipped with 2 programmable relays configured as volt free contact. Enter the Service Mode and Select Configure. Select "Relay Control"

Service	Exit		Mute Buzzer	Reset
Change Date/Time			Add/Delete Zone	
Change Text			Network	
Configure Zones			Language	
Change Password			Network Protocol	
Relay Control			Power Supply	
Programmable Input				

Select the type of relay either "Aux Relay" or "Fault Relay"

Service	Exit		Mute Buzzer	Reset
<div style="background-color: black; color: white; padding: 5px; display: inline-block; margin-bottom: 10px;">Aux Relay</div> <div style="border: 1px solid black; padding: 5px; display: inline-block; margin-bottom: 10px;">Fault Relay</div>				

Service	Exit		Mute Buzzer	Reset
<div style="border: 1px solid black; padding: 5px; display: inline-block; margin-bottom: 10px;">Aux Relay</div> <div style="background-color: black; color: white; padding: 5px; display: inline-block; margin-bottom: 10px;">Fault Relay</div>				

Select the desired mode

Service	Exit		Mute Buzzer	Reset
On Fire				
On Pre-Alarm				
On Fault				
On Test				
On Disablement				
Not Required				

Programmable Input

The Repeater is equipped with a programable input which can operate across the network if the repeater is programmed as active.

Enter the Service Mode and Select Configure. Select "Programmable Input"

Service	Exit		Mute Buzzer	Reset
Change Date/Time			Add/Delete Zone	
Change Text			Network	
Configure Zones			Language	
Change Password			Network Protocol	
Relay Control			Power Supply	
Programmable Input				

Select Zone into which device will be added

Service	Exit		Mute Buzzer	Reset
Reset			Fire	
Evacuate			Pre-Alarm	
Silence			Fault	
Not Required			Prog Input Text	

Select the mode of operation from the menu

Network

Enter the Service Mode and Select Configure. Select "Network", This menu defines whether messages are broadcast across the network or remain local.

Service	Exit	Mute Buzzer	Reset
Change Date/Time		Add/Delete Zone	
Change Text		Network	
Configure Zones		Language	
Change Password		Network Protocol	
Relay Control		Power Supply	
Programmable Input			

Select the specific required . E.g "Reset"

Service	Exit	Receive message over network
Reset		Network
Evacuate		Network
Silence		Network
Fire		Network
Fault		Network
Pre-Alarm		Network

Select if Network is required to be on/off

Service	Exit	Receive message over network
Reset		Not Required
Evacuate		Network
Silence		Network
Fire		Network
Fault		Network
Pre-Alarm		Network

Language

To activate the touch screen, touch the top left corner of the screen until the screen illuminates. To enter the supervisor mode touch the supervisor button and enter the service passcode.

Enter the Service Mode and Select Configure.

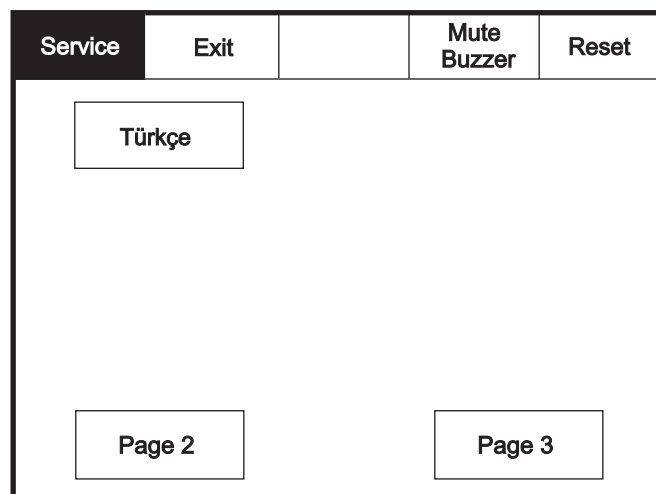
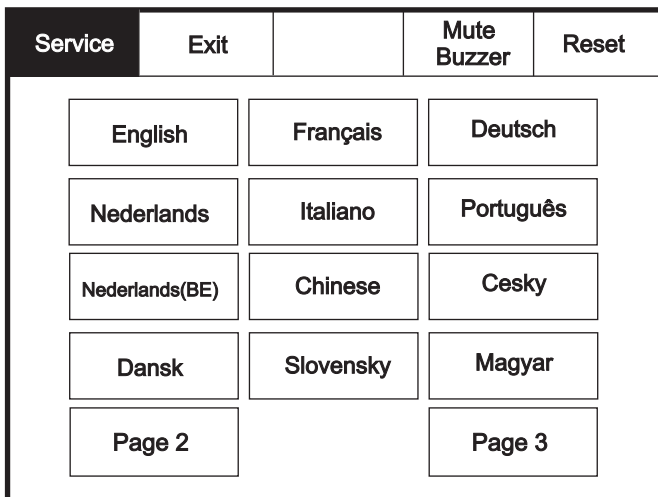
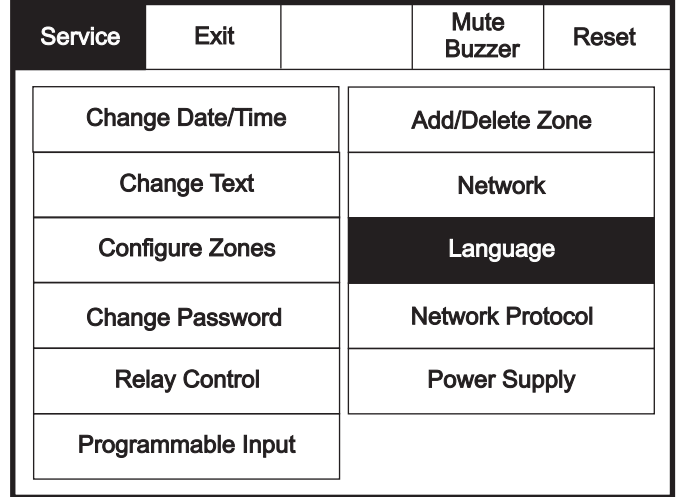
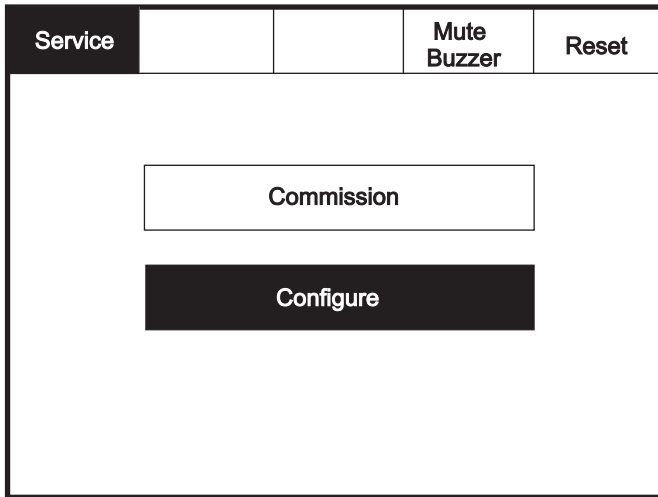

Select "Language" from the Configure Menu Screen.

Then press select required language from the 3 available pages.

Network Protocol

To activate the touch screen, touch the top left corner of the screen until the screen illuminates. To enter the supervisor mode touch the supervisor button and enter the service passcode.

Enter the Service Mode and Select Configure.

Service	Exit		Mute Buzzer	Reset
Change Date/Time			Add/Delete Zone	
Change Text			Network	
Configure Zones			Language	
Change Password			Network Protocol	
Relay Control			Power Supply	
Programmable Input				

Service	Exit			Reset
<div data-bbox="563 1196 906 1272" style="border: 1px solid black; padding: 5px; margin: 10px auto; width: 200px;">Network Protocol V1</div> <div data-bbox="563 1341 906 1417" style="border: 1px solid black; padding: 5px; margin: 10px auto; width: 200px;">Network Protocol V2</div>				

Power Supply

To activate the touch screen, touch the top left corner of the screen until the screen illuminates. To enter the supervisor mode touch the supervisor button and enter the service passcode.

Enter the Service Mode and Select Configure.

Service	Exit		Mute Buzzer	Reset
Change Date/Time			Add/Delete Zone	
Change Text			Network	
Configure Zones			Language	
Change Password			Network Protocol	
Relay Control			Power Supply	
Programmable Input				

Service	Exit			Reset
<div data-bbox="561 1200 904 1272" style="border: 1px solid black; padding: 5px; margin: 10px auto; width: 200px;">Internal Power</div> <div data-bbox="561 1346 904 1417" style="border: 1px solid black; padding: 5px; margin: 10px auto; width: 200px;">External Power</div>				

Password Protection

Please enter Passcode	1	2	3
	4	5	6
	7	8	9
	ok	0	←

The system has password protection which restricts access to the DISABLE Menu and to TEST/COMMISSIONING MODE. The password is a four digit code and the default number is 2214. The password entry screen is accessed via the supervisor mode button. Press supervisor mode and the password entry screen will be displayed, type in the passcode and press Ok. If the wrong password is entered three times further access to the system is denied.

Section 4

Appendix

System Wiring

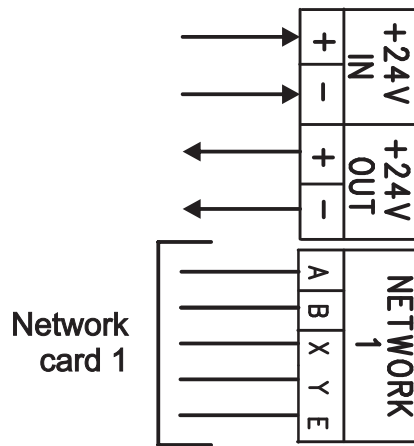
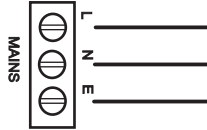

Use Network 1 for standard network

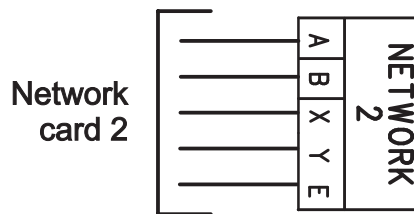

Use both Network 1 & 2 for Dual Network

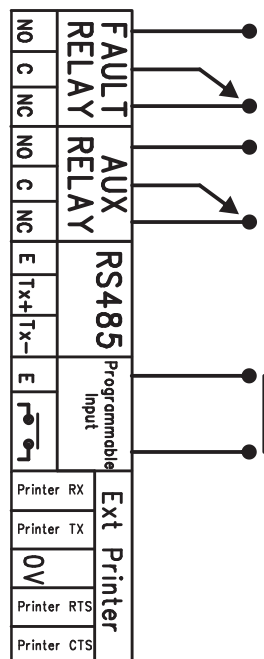

Switch / contactor, timer etc.
(apply no voltage)