

Install confidence with **xDetect**





It's what we do

Fire systems you can depend on

Robust fire alarm systems and devices are essential to the protection of people, property and business continuity in commercial buildings. Early detection of a fire risk can prevent catastrophic damage. The risks associated with failure - from loss of life to irreparable reputational damage, make the selection of a fire system a vitally important process.

To ensure the highest levels of safety, all of the people involved in the purchase, installation, commissioning, operation and maintenance of a fire system need to know that the chosen system, and all associated devices, can be relied upon.

Eaton brings decades of expertise to the development of fire systems working closely with industry organisations and customers to shape the future of fire safety. Products within the range, spanning state-of-the-art control panels, detectors and alarm devices, are seamlessly compatible with each other, and are quality assured through a process of rigorous testing.

Industry firsts



Visual alarm device

First low-current solution to meet EN54-23 standard for visual alarm devices



Touchscreen panel

First to introduce a touchscreen on a fire alarm system control panel with Menvier



Resettable call point

Creator of the resettable manual call point.



xDetect Overview

- Two enclosures- 1-2 loop small and 2-4 loop large
- Different door options- 128 zonal indicator, network panel
- Modular system architecture- configurable backplane, optional colour-coded cards & modules
- EN54 certified, LPCB approved
- Networkable up to 250 panels
- USB connection
- Intuitive colour-coded touchscreen interface
- Batteries not included



Joined-up design that goes the full distance

Eaton has gone back to first principles with xDetect to optimise every stage of the user journey. By listening to installers to understand their priorities, it's created a mid-tier fire panel that's simpler to use, easier to scale and extremely dependable.

From product selection, installation and commissioning through to end use, servicing and expansion, xDetect demonstrates a **consistent design philosophy** that puts installers and users first.



Flexible

Modular system architecture

600mA current per loop

Matrix based cause & effect programming



Safe & secure

Cybersecure - An Eaton secure-by-design solution

"Fault tolerant" ring design network

Built in redundancy for when a fault does occur



Instantly familiar

Easy to use "tablet-like" 7" colour touchscreen

Large, clear buttons & icons

Adaptive, high contrast colour coding

Go modular and shape your own fire offering

Early customer research for xDetect showed that installers and specifiers wanted the **independence to quote for a fire panel with customised capabilities**. It means that you're **better placed to manage your offer** and deliver effective system designed around your customers needs.

xDetect base units comes small or large supporting either a 7- or 12-card frame. Customisation and upgrades are seamless and errorproof with four "plug in and go" colour-coded cards and a range of door options.

"Plug in and go" cards

Customisation and upgrades are seamless and errorproof with four "plug in and go" colour-coded cards and a range of door options.

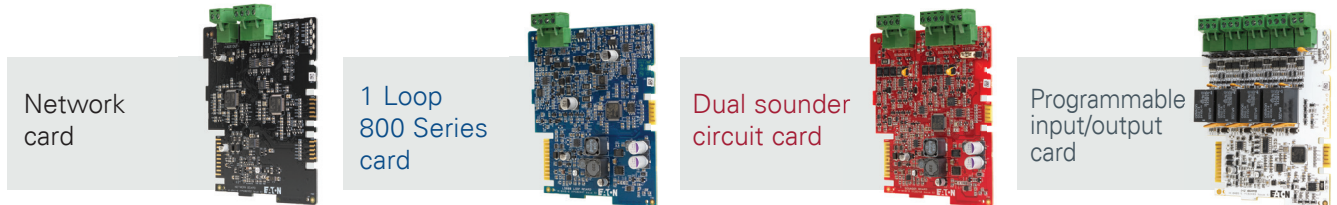

A look inside – Small enclosure

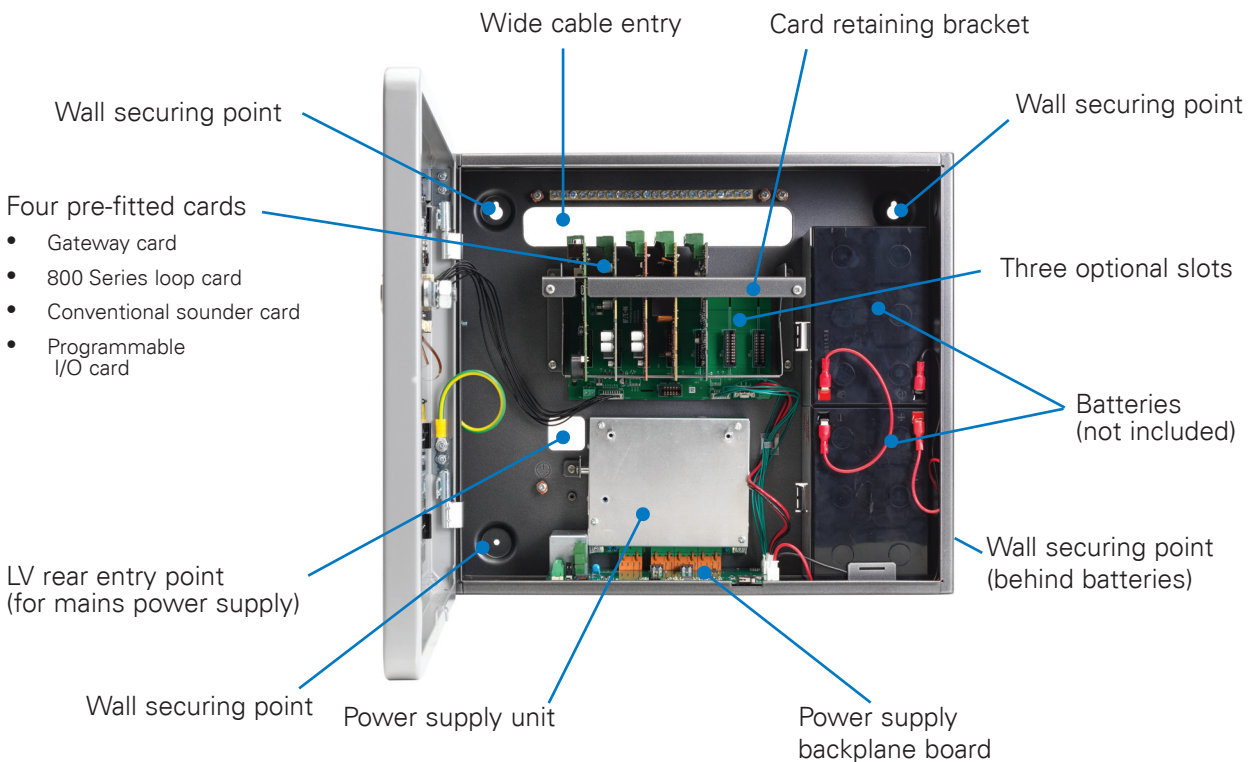

Three ways it puts installers in the driving seat

<p>1 Flexibility xDetect is easy to expand and adapt in line with building owners' changing needs thanks to its modular system architecture.</p>	<p>2 You're the expert No more "over specifying a site"; create bespoke system solutions every time- all while carrying minimal stock of "basic units".</p>	<p>3 Rapid fault-finding Single swap of cards with local status LEDs means you can resolve issues without having to disturb the rest of the system.</p>
--	---	---

Less cabling, cheaper projects; no compromise on safety

Say goodbye to redundant cable

A typical panel network installation requires a large amount of planning and cabling across a campus. xDetect uses a streamlined RS-485 network, optimising cable costs while providing maximum safety.

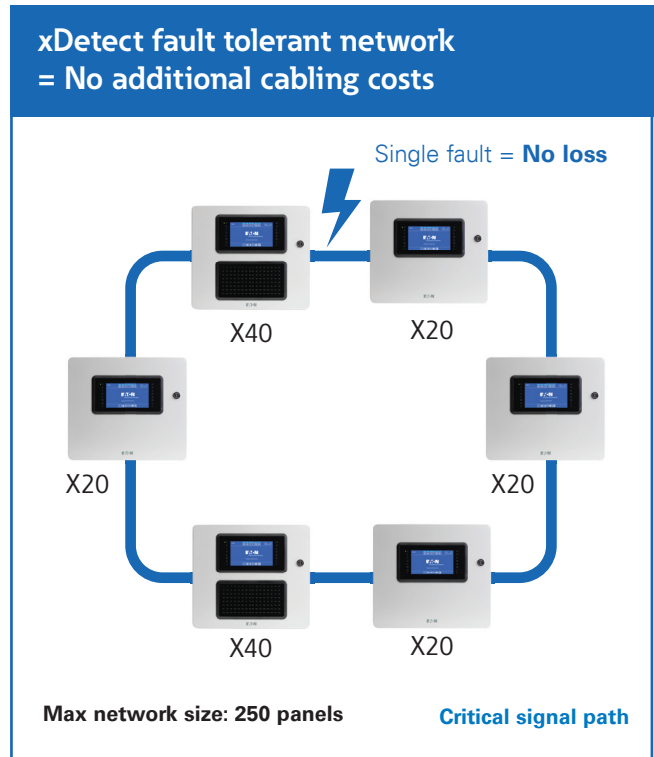
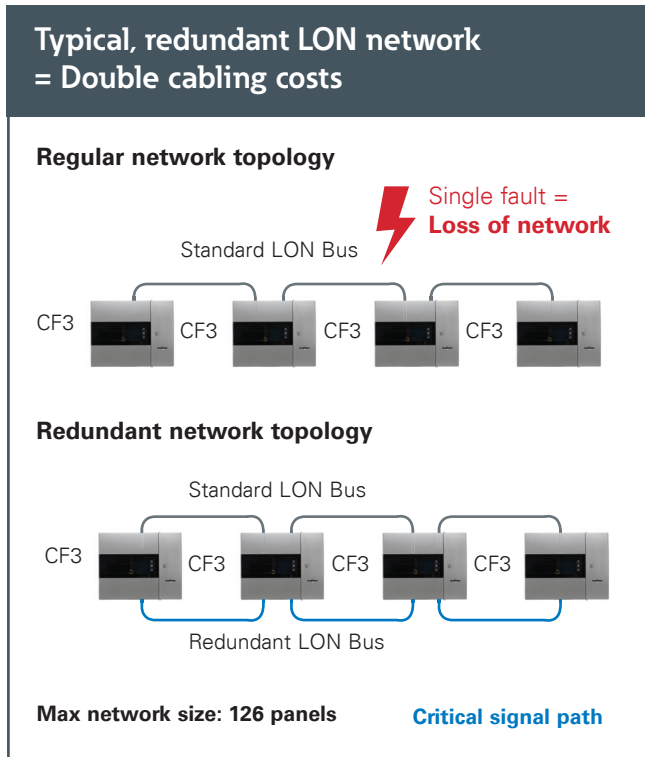

The most powerful panel we've ever created

To support many devices, a typical panel would require many circuits and a large amount of return path cable. xDetect's 600mA current per loop means more high powered devices can be powered per loop, giving large savings through cable length.

CF3000

- Max current per loop: **220mA**
- Max loop distance: **2km**
- 13x Visual alarm devices: **3 loops**
- Max No. addressable devices per loop: **200**

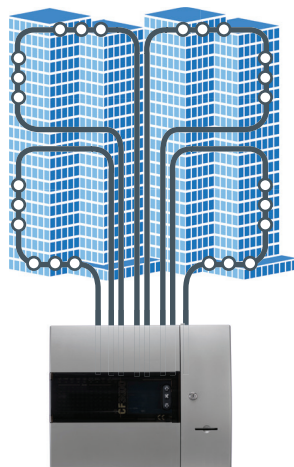

xDetect

- Max current per loop: **600mA**
- Max loop distance: **2km**
- 13x Visual alarm devices: **1 loops**
- Max No. addressable devices per loop: **200**

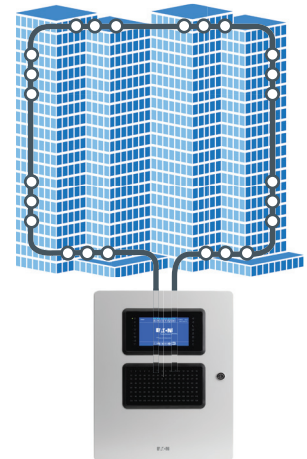

Greater resilience and rapid on-site troubleshooting

Faults can happen at any time when sites go live – particularly when demanding schedules are constantly evolving. Premises management need to be kept informed about any changes in fire coverage and clearly understand any daily impact on their fire evacuation strategy. xDetect simplifies this entire process. Critically, **any loop card**

failure is confined to one loop circuit only – all others remaining fully operational. This is by design and allows for segmented protection against faults and loss of coverage. Downtime is minimised completely as each card provides clear status indication. It means technicians can **identify issues quickly and rectify with minimal effort**, with each frame allowing for swapping of the affected card without disturbing other system functionality.

From an end user's perspective this adds significant value. Any issues can be dealt with swiftly without powering down the entire system, running diagnostics and losing fire coverage in areas unrelated to the fault's origin. The result? **Less expensive, inconvenient downtime** while providing more peace of mind and control for building occupants.

Example timeline of events:

System with no redundancy

- 1 Single loop card PCB fails
- 2 Loss of 2 loops of detection
- 3 Fault is recorded on the panel and reviewed by relevant engineer
- 4 The building is closed
- 5 Panel is replaced
- 6 Building fully reopens

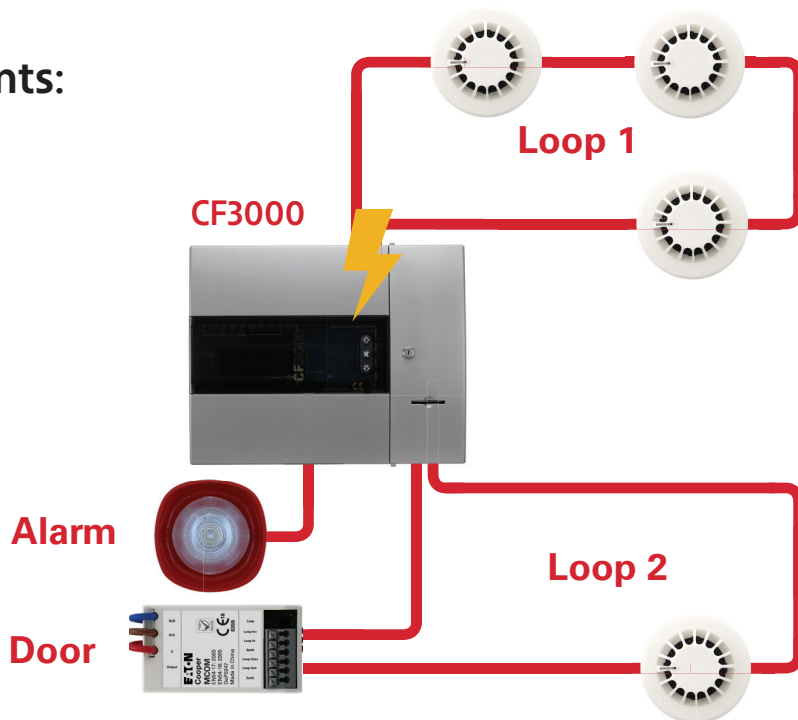

Example timeline of events:

System with redundancy

- 1 Single loop card PCB fails
- 2 Loss of 1 loop of detection
- 3 Fault is recorded on the panel and reviewed by relevant engineer
- 4 Area of building covered by loop 1 is closed (rest of building remains open)
- 5 Faulty loop card is replaced
- 6 Area of building previously closed, reopened

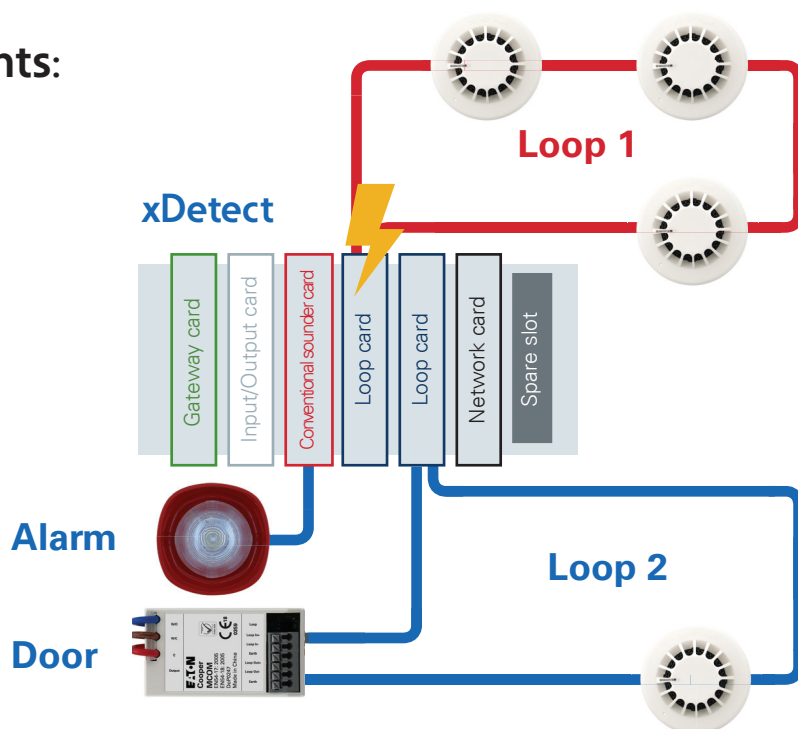

Changing the face of fire panel design

Multiple sub-menus, small screens and lack of colour on fire alarm panels have historically made them awkward to navigate. xDetect features a clear, tablet-like interface that creates a feeling of easy-to-use confidence so critical in an emergency.

It builds on the achievements of our legacy brand Menvier, a pioneer in developing touchscreen displays for fire

alarm panels. Its restrained design **translates into fast, easy navigation for users which will be popular with installers, facility managers and fire fighters alike.**

Eaton's guiding principle for xDetect is that every user – no matter what level of fire panel knowledge – should immediately feel familiar with it in the same way they interact with everyday digital devices.

Instantly familiar, easily learnt

Five features of xDetect's interface in focus

- 1 High contrast colour coding and simple text/graphics** guide users quickly and effectively – blue indicating normal conditions, amber highlighting a fault or other issue, and red designating fire.

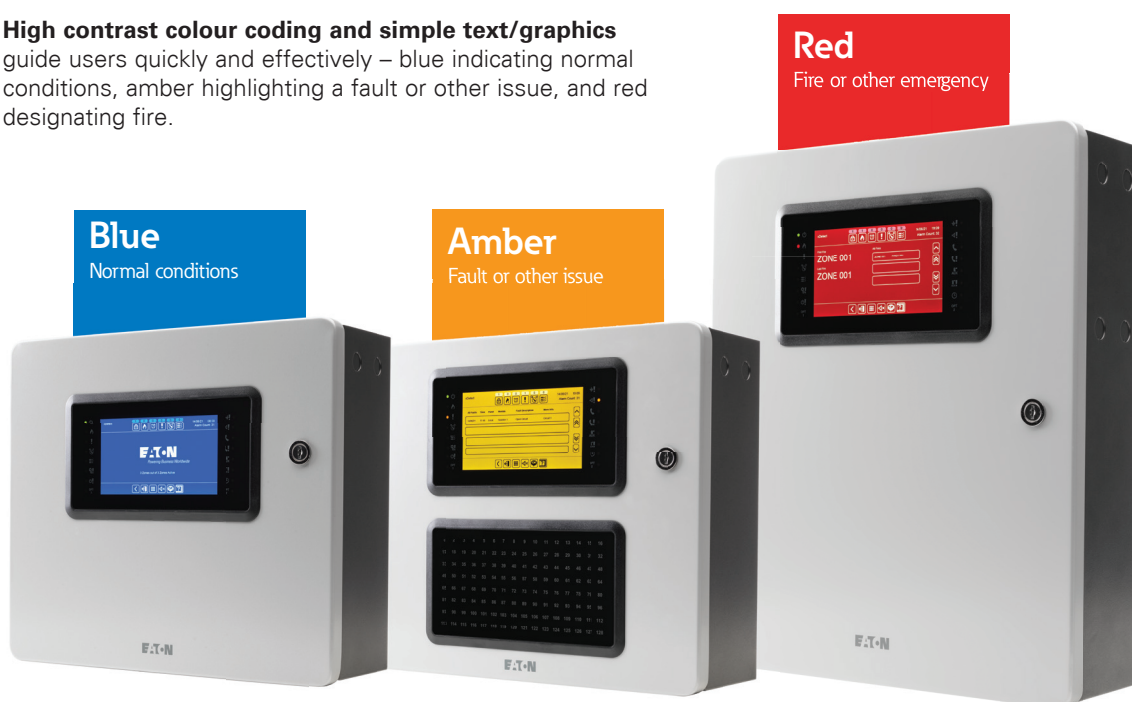

- 2 A consistent layout** across all screens and modes ensures that common elements, such as scroll bars and buttons, are always in the same place. Anything with a box around it is interactive. And anything without one, isn't.

- 3 Quick access rows** 'Always visible' top and bottom row buttons so you can access specific menus or areas much faster.



- 4 Large, clear buttons & icons** make the panel ideally suited for those with poor eyesight, or when smoke reduces visibility.

- 5 Flex display by user:** Highest level access – such as for an engineer – will show more screen options than for someone with basic access rights.

All installations made simple with xDetectWorks

What is xDetectWorks?

xDetectWork is the powerful PC programming software design to make system design and configuration simple with xDetect.

It is free and is activated with a license code to be generated by the Eaton Fire Technical Support team once training has been completed.

- USB connection
- PC based application
- Requires a free license to activate

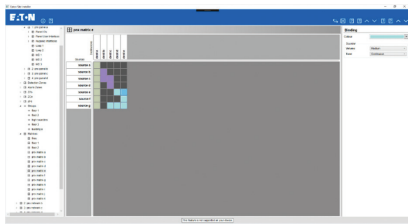

Matrix based cause & effect (C&E) programming

- Straightforward to program
- Save engineering time/costs
- Handover projects faster

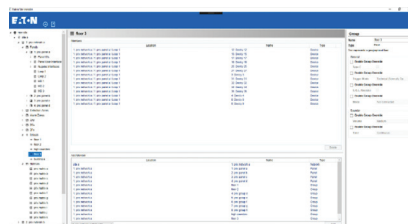

Groups

- Create geographical structures
- Better represent the field layout
- Customised groups for specific C&E

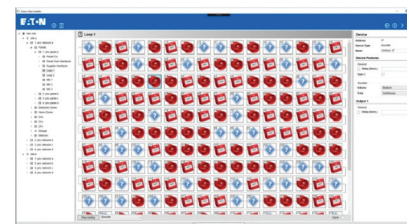

Type IDs

- Easily identifiable
- Unique definitions
- Simple to edit settings

The best of both: choose basic or advanced cause & effect depending on the site complexity

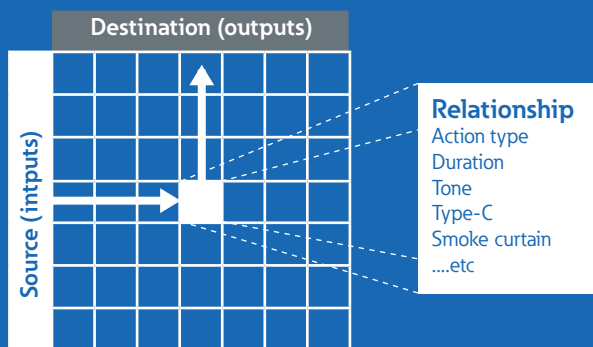

Basic

- Simple to program
- Easily understood by others
- Basic systems
- Fast to implement
- Easy to check and handover

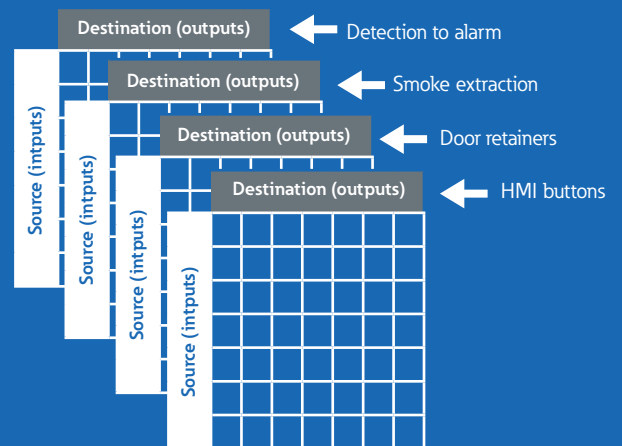

Advanced

- Segment programming- split types of output such as door retainers, HMI buttons etc
- Commission complex systems faster
- Easier to maintain complex systems
- Simple to verify changes with confidence, particularly helpful if changes or faults are being added/reviewed many years after the initial installation

Protecting people, property and data

Cyber attacks – The threat to buildings

By 2025, 41.6 billion connected devices will be generating 79.4 zettabytes (ZB) of data worldwide¹. From manufacturing and testing to installation and service, it's a seismic shift already creating huge opportunities for organisations. But at the same time, the trend brings big risks.

At a minimum, a security breach can result in operational downtime and/or data loss, in turn seriously impacting reputation, customer loyalty and the bottom line. At worse, a breach could also have implications for personal safety – especially in the context of fire detection systems on which lives depend.

Historically, fire detection systems were typically hardwired and un-networked. However, Internet of Things (IoT) technology now means they can be connected at any time and from anywhere – for example enabling them to communicate with heating, ventilation and air-conditioning (HVAC), security and other building management/safety systems, such as those in alarm receiving centres (ARCs). If such networks are poorly designed and maintained, they're effectively leaving the door wide open to cyberattacks by bad actors. These can threaten an organisation's wider IT infrastructure driven by multiple motives ranging from the political and ideological, through to the purely financial.

Did you know?

4 in 10 Smart building automation control systems were cyber attacked in the first half of 2019²

Some of the risks



Theft of assets



Data breach



People's safety



Terrorism



Anti-competitive attacks

HVAC system to customer bank information

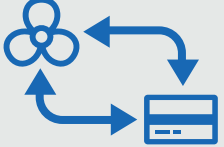

Target stores in the US were hacked via the company's HVAC system, which allowed the attackers to access lucrative customer data records³

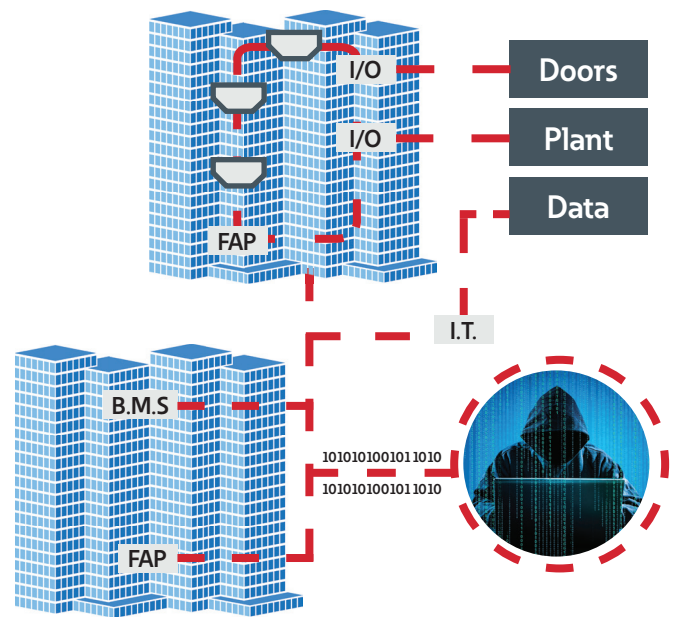

PSTN shutdown to increase the importance of cybersecurity

Predicted closure dates



2025
UK⁴



2030
World⁵

One medium-term change set to have a big impact on the importance of fire market cybersecurity is the shutting down of PSTN networks – the traditional method of connecting fire systems to Alarm Receiving Centres (ARCs) – which will be replaced by digital IP.

The switch-off, scheduled in the UK by 2025⁴ and globally by 2030⁵, reflects the fact that the PSTN system has become outdated, is expensive to maintain and there are fewer people around with

the necessary PSTN skills.

Millions of alarms systems will need to be reconfigured to meet this change, including four million in the UK alone (2017 figures). The upside is that the shift to IP networks opens up possibilities to significantly improve the information that fire services have when attending a call out.

In the future, a 'critical information pack' on the event, including building layouts, fire zone charts and details of fire spread, could

be sent directly from the fire system to 'smart' fire engines as they travel to the scene⁶. The system could also raise the alarm to an ARC. Such improvements in how fire services respond will increase the chances of protecting people and property.

However, as the data flow increases, the importance of cybersecurity becomes more critical.

¹ "The Growth in Connected IoT Devices is Expected to Generate 79.4ZB of data in 2025, According to a New IDC Forecast" Business Wire, 2019 <https://www.businesswire.com/news/home/20190618005012/en/The-Growth-in-Connected-IoT-Devices-is-Expected-to-Generate-79.4ZB-of-Data-in-2025-According-to-a-New-IDC-Forecast>

² "Smart buildings threat landscape" Kaspersky, 2019 https://www.kaspersky.com/about/press-releases/2019_smart-buildings-threat-landscape

³ "Target hackers broke in via HVAC company" Krebs Security, 2014 <https://krebsonsecurity.com/2014/02/target-hackers-broke-in-via-hvac-company/>

⁴ "FIA spells out challenges surrounding PSTN shutdown" IFSEC Global, 2017 <https://www.ifsecglobal.com/global/fia-spells-out-challenges-surround-pstn-shut-down/>

⁵ "Out with the old - phasing out of PSTN/POTS globally by 2030" spearline, 2019 <https://www.spearline.com/blog/post/out-with-the-old-phasing-out-of-pstn-pots-globally-by-2030/>

⁶ "Smart fire engines to the rescue" The Telegraph, 2019 <https://www.telegraph.co.uk/business/future-technologies/smart-fire-engines/>

Developed with cybersecurity in its DNA

xDetect is an Eaton secure-by-design panel that simplifies control of fire alarms and other peripherals in commercial buildings, protecting people, property and data. At its heart is the **highest level of cybersecurity**, enabling secure communications and protecting both data and assets from hackers. Entirely futureproof and ready for remote access, xDetect can be safely integrated into a Building Management System (BMS) and the Internet of Things (IoT).

xDetect has followed Eaton's Secure Development Life Cycle (SDLC) cybersecurity assessment process through all stages of the design development. This process features protocol communication checks which are integral to ensuring the xDetect panel will only communicate with authorised peripherals. Tamper switches are also installed by default to ensure that any physical access to the panel is always recorded.



About our Secure Development Life Cycle (SDLC) process

Our commitment to working at the highest cybersecurity standards is well-established and increasingly shaping its product range. The company introduced the first research and testing facility approved to participate in ULs

Cybersecurity Client Lab Validation program in Pittsburgh, Pennsylvania. And in 2018, UL approved a second Eaton lab to join the programme — another industry first — in Pune, India.

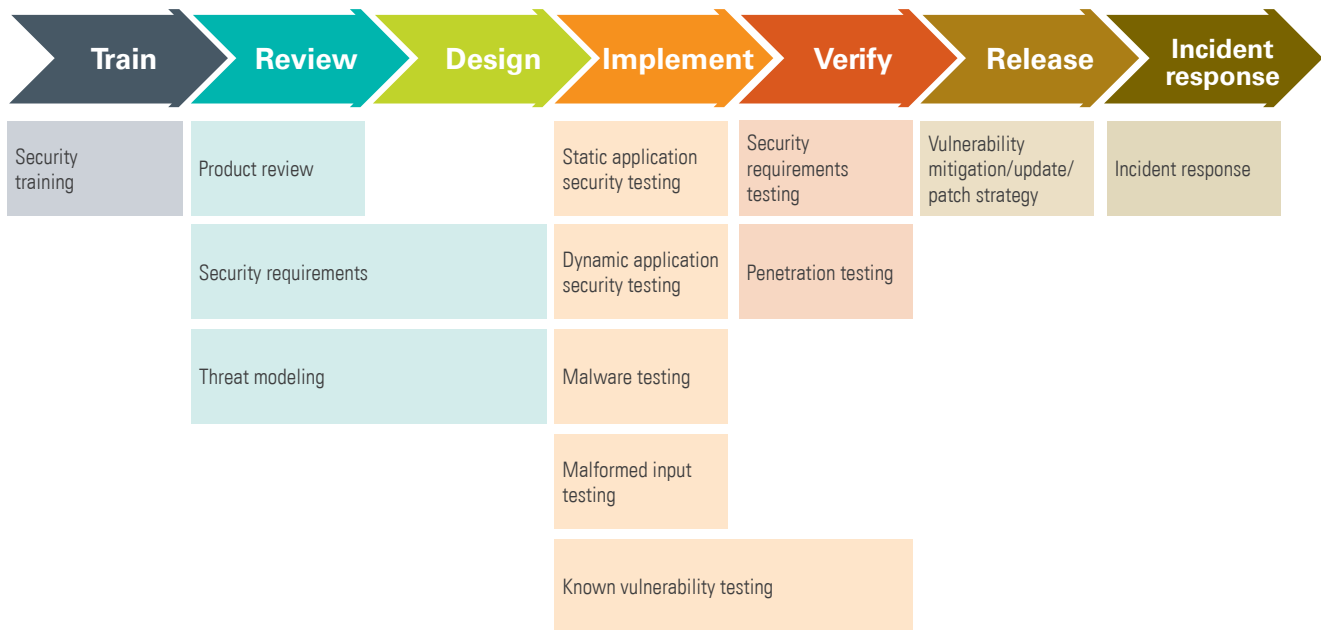

Two features in xDetect identified by the SDLC process

- 1 **Protocol communication checks** ensure that only authorised peripherals can communicate with the panel
- 2 **Tamper switches** installed by default mean that any physical access to the panel is always recorded

Learn more at Eaton.com/Cybersecurity



Small enclosures



xDetect is an addressable fire alarm control panel featuring an instantly familiar, tablet-like user interface. Its adaptive touchscreen automatically changes colour in line with the fire system's status. This feature enables users to monitor, at a glance, the status of a building's fire peripherals and zones so that faults can be addressed swiftly and fires minimised. The panel protects data and assets from hackers, ensuring secure communications, and has been designed with industry-leading levels of cybersecurity, making it future-ready for BMS and IoT connectivity.

xDetect's end-to-end design concept minimises time-on-site, simplifying selection, installation, commissioning and service thanks to features such as error-proof colour coding and modular architecture. Installation and maintenance times and costs are reduced further by xDetect's ring design. As panels can be connected in a ring design network, the system continues to work even in the event a network cable short circuits. This makes the use of a redundant network unnecessary, significantly reducing cabling and associated costs. A scalable solution, xDetect is easy to expand and adapt in line with building owners' changing needs thanks to its modular system architecture. It can be upgraded effortlessly in line with changing standards and regulations through an intuitive, colour-coded scalable loop configuration with easy-to-swap system cards.

Large enclosures



Key features

- Flexible modular card based system with redundancy
- Fault tolerant ring network design with built in isolators
- Cybersecure – An Eaton secure-by-design solution
- 600mA Maximum current per loop
- Multi-language selection capability
- Powerful matrix based cause & effect programming with xDetectWorks programming software
- "Tablet like" 7" colour touchscreen
- Instantly familiar interface with high contrast colour coding that is simple to operate and learn
- Available in two sizes: Small (7 card frame) and large (12 card frame) enclosure options
- EN54-2, EN54-4 certified
- LPCB approved

Order codes

Modular cards

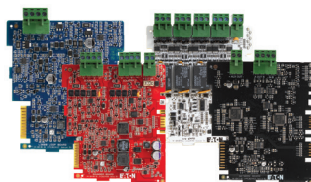

- Colour coded cards
- Easy identification in the field
- Local status LEDs for each card
- Simple maintenance

Control panels

Enclosure	Description	Model reference	Order code
Small	xDetect Addressable CIE Panel 2 Loop Enclosure	EFXD01020	EFXD01020
Small	xDetect Addressable CIE Panel 2 Loop Enclosure + 128 Zonal Indicator	EFXD01022	EFXD01022
Large	xDetect Addressable CIE Panel 4 Loop Enclosure	EFXD01040	EFXD01040
Large	xDetect Addressable CIE Panel 4 Loop Enclosure + 128 Zonal Indicator	EFXD01042	EFXD01042

Cards & backplane options/spares

Description	Model reference	Order code
xDetect Loop Card 1L Protocol 800	EFXD05001	EFXD05001
xDetect Smoke Management Control Loop	EFXD05002	EFXD05002
xDetect Sounder Circuit Card 2 Outputs	EFXD05020	EFXD05020
xDetect Programmable I/O card	EFXD05030	EFXD05030
xDetect Network Card	EFXD05040	EFXD05040
xDetect CIE Int. Power Supply 150W	EFXD05051	EFXD05051
xDetect CIE Int. Dual PSE Backplane	EFXD05052	EFXD05052
xDetect CIE Int. Single PSE Backplane	EFXD05053	EFXD05053
xDetect Zonal Indicator Board – 128 Zonal Indicator	EFXD05060	EFXD05060
xDetect CIE Backplane Large Enclosure	EFXD05081	EFXD05081
xDetect CIE Backplane Small Enclosure	EFXD05082	EFXD05082

Networked systems

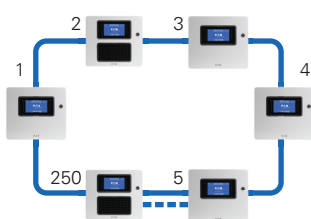

A fault tolerant loop network means no loss of communication during a single fault, reducing cable costs across a maximum of 250 panels per network.

Panel door options

Description	Model reference	Order code
xDetect CIE Door Small HMI only	EFXD05091	EFXD05091
xDetect CIE Door Large HMI only	EFXD05092	EFXD05092
xDetect CIE Door Small 128 Zonal Indicator	EFXD05093	EFXD05093
xDetect CIE Door Large 128 Zonal Indicator	EFXD05094	EFXD05094
xDetect CIE Door Large 256 Zonal Indicator	EFXD05095	EFXD05095

Note: In the first release (MR1.0), the system will support a maximum network size of 20 panels. For MR1.1, the system will support a maximum network size of 126 panels. Please contact Eaton technical support for further guidance.







	EFXD01020	EFXD01022	EFXD01040	EFXD01042
Brand	Eaton	Eaton	Eaton	Eaton
Enclosure	Small	Small	Large	Large
HMI	7" Colour touchscreen	7" Colour touchscreen	7" Colour touch screen	7" Colour touchscreen
Zonal Indicator	None	128	None	128
Approval	EN54-2, EN54-4	EN54-2, EN54-4	EN54-2, EN54-4	EN54-2, EN54-4
Accreditation	LPCB 378q/01	LPCB 378q/03	LPCB 378q/02	LPCB 378q/04
Max. Zones (per CIE)	256	256	256	256
Number of Loops	1-2	1-2	1-4	1-4
Max. Length of Loops	2km	2km	2km	2km
Max. Load per Loop (Inputs & Outputs)	600mA	600mA	600mA	600mA
Max. No. of Addressable Points per Loop	200	200	200	200
Max. No. of Addressable Points per C.I.E	400	400	800	800
Max. No. of Alarming Devices per Loop Card (based upon beacon with 4.1mA current)	Up to 131	Up to 131	Up to 131	Up to 131
Max. No. of Alarming Devices per Sounder Card (based upon lowest operating current of RoLP)	Up to 106	Up to 106	Up to 106	Up to 106
Max. No. of Fire Alarm Devices per C.I.E	Up to 262 (requires 1 additional Loop card from standard)	Up to 262 (requires 1 additional Loop card from standard)	Up to 262 (with 1 PSU - requires 1 additional Loop card from standard) Up to 524 (with 2 PSUs - requires 1 additional PSU & 3 loop cards from standard)	Up to 262 (with 1 PSU - requires 1 additional Loop card from standard) Up to 524 (with 2 PSUs - requires 1 additional PSU & 3 loop cards from standard)
Pre-Fitted Cards	1x Gateway 1x Loop 1L Protocol 800 1x Programmable I/O 1x Sounder Circuit 2 Outputs	1x Gateway 1x Loop 1L Protocol 800 1x Programmable I/O 1x Sounder Circuit 2 Outputs	1x Gateway 1x Loop 1L Protocol 800 1x Programmable I/O 1x Sounder Circuit 2 Outputs	1x Gateway 1x Loop 1L Protocol 800 1x Programmable I/O 1x Sounder Circuit 2 Outputs
System Operating Voltage	20.4-28V (VBUS)	20.4-28V (VBUS)	20.4-28V (VBUS)	20.4-28V (VBUS)
Mains Input Supply	230Vac +10%, -15% 50/60Hz	230Vac +10%, -15% 50/60Hz	230Vac +10%, -15% 50/60Hz	230Vac +10%, -15% 50/60Hz
Standby Duration	Up to 24Hrs (Dependant on loop loading and battery configuration)	Up to 24Hrs (Dependant on loop loading and battery configuration)	Up to 24Hrs (Dependant on loop loading and battery configuration)	Up to 24Hrs (Dependant on loop loading and battery configuration)
Maximum Battery	2 x 12V dc (12Ah)	2 x 12V dc (12Ah)	4 x 12V dc (12Ah)	4 x 12V dc (12Ah)
Weight (without batteries)	8.4kg	8.3kg	11kg	10.9kg
Ingress Protection	IP30	IP30	IP30	IP30
Dimensions H x W x D - Product (mm)	374 x 426 x 148	374 x 426 x 148	527 x 433 x 148	527 x 433 x 148
Dimensions H x W x D - Packaged (mm)	630 x 500 x 310	630 x 500 x 310	630 x 500 x 310	630 x 500 x 310
Construction	1.5mm Mild Steel	1.5mm Mild Steel	1.5mm Mild Steel	1.5mm Mild Steel
Cable Entry	23x 20mm diameter at top 2x 20mm diameter on each side 2x 20mm diameter on bottom 1x Rectangular knockout at rear- W 284 X H 35 mm	23x 20mm diameter at top 2x 20mm diameter on each side 2x 20mm diameter on bottom 1x Rectangular knockout at rear- W 284 X H 35 mm	23 x 20mm diameter at top 4 x 20mm diameter on each side 2 x 20mm diameter on bottom 1x Rectangular knockout at rear- W 284 X H 35 mm	23 x 20mm diameter at top 4 x 20mm diameter on each side 2 x 20mm diameter on bottom 1x Rectangular knockout at rear- W 284 X H 35 mm
Operating Temperature	-5C to +40°C	-5C to +40°C	-5C to +40°C	-5C to +40C
Humidity (non condensing)	95%	95%	95%	95%
Compatible with	Visit www.Eaton.com/xDetectCompatibleDevices to see the latest list of compatible peripherals			





Information is believed to be accurate, however no representation or warranty is given and Eaton assumes no liability with respect to the accuracy of such information. The information provided in this document is subject to change without notice.

Sounders, beacons & remote indicators



Sounders

	Addressable wall sounder CAS381
	Addressable wall sounder (Australian Tone) CAS381AU
	Addressable wall sounder (Weatherproof) CAS381WP
	Addressable wall sounder (Weatherproof, Australian Tone) CAS381AU-WP



Sounder beacons

	Addressable wall sounder beacon CASB383
	Addressable wall sounder beacon (Australian Tone) CASB383AU
	Addressable wall sounder beacon (Weatherproof) CASB383-WP
	Addressable wall sounder beacon (Weatherproof, Australian Tone) CASB383AU-WP

Beacons





	Addressable beacon CAB382
	Addressable beacon (reset on reset) CAB382RR

Remote indicators



	Addressable remote indicator MRIAD
	Addressable remote indicator (reset on reset) MRIADRR

Visual alarm devices (VADs), installation accessories & repeater panels

Wall VADs

	Red plastic, white flash, shallow base CAB492WS
	Red plastic, red flash, shallow base CAB482WS
	Red plastic, red flash, deep base CAB482WD
	Red plastic, white flash, deep base CAB492WD



Wall sounder VADs

	Red plastic, red flash CASB483
	Red plastic, white flash CASB493
	Red plastic, white flash, weatherproof CASB483WP
	Red plastic, red flash, weatherproof CASB493WP

Wall sounder VADs Open class

	Red plastic, white flash, open class CASB393 / CASB393-VSR
	Red plastic, white flash, weatherproof, open class CASB393WP / CASB393WP-VSR

Installation accessories

	Device programmer CF800PROG
	Loop tester kit LP800KIT



Ceiling VADs

	Red plastic, red flash, shallow base CAB482CS
	Red plastic, white flash, shallow base CAB492CS

Repeater panels

	Passive repeater CF3000PRG
---	--------------------------------------

Manual call points

	Addressable manual call point CBG370S
	Addressable manual call point (Weatherproof) CBG370SWP

Detectors

Point



Multi-mode heat
CAH330



Optical smoke
CAP320



Photo-thermal
CAPT340

Standard base



Addressable detector base
CAB300

Speciality



Reflective beam 50-100m
MAB100R



Reflective beam 50-100m
(emerging market)
MAB100R-EM



Reflective beam 5-50m
MAB50R



Reflective beam 5-50m
(emerging market)
MAB50R-EM

Sounder bases



Addressable sounder base
CAS380



Addressable wall sounder
(Australian Tone)
CAS380AU

Sounder beacon bases



Sounder beacon base
CASBB384



Sounder beacon base (bell tone)
CASBB384-B

Sounder VAD base



Open class, white flash
CASBB394 /
CASBB394-VSR

Base sounder plate



Sounder cover plate
CASC

Interfaces

Micro



Micro single channel output unit
(reset on reset)
MCOM-R



Micro single channel input unit
MCIM



Micro single channel output unit
MCOM



Micro single channel output unit
(fan controller)
MCOM-FC



Micro single channel output unit (sounder)
MCOM-S



Micro zone monitor unit
CIU872

Micro enclosure

Micro single channel unit enclosure
ULBU

Mimic relay



4 Way mimic relay board (4 in, 4 out)
CIOP4



8 Way mimic relay board (4 in, 8 out)
CIOP8

230V Relay



230V Relay I/O unit
CMIO353

4-Way controller



4-Way sounder controller
CSC354CPR

3 Channel I/O



3 Channel I/O unit (reset on reset)
CIO351



3 Channel I/O unit (reset on silence)
CIO351S



3 Channel I/O unit (triple address)
CIO351SST

4-20mA



4-20mA interface
CGI420



4-20mA interface
CIT420

Fan



Fan controller (6 channel, surface/rack mountable)
FC6

Door release



Door release module
CIOP-7273

Spur



Spur isolator unit
CZMU352



Spur isolator unit (intrinsically safe)
CZMU352-IS

In comparison: The addressable fire control panel range

Unique selling point

Improvement to legacy



CF2000

CF1100

CF1200

CF3000

R6000

xDetect (Small)

xDetect (Large)

	CF2000	CF1100	CF1200	CF3000	R6000	xDetect (Small)	xDetect (Large)
Series variants	DF2000 FX2000	DF6100 FX6100	DF61002 FX61002	DF6000 FX6000	N/A	CXD0120 JXD0120 MXD0120	CXD0140 JXD0140 MXD0140
Application	Small sites	Small sites	Small sites	Medium to large sites	Medium to large sites	Small sites	Medium to large sites
No. Loops	2	1	2	2, 4	2, 4	1 per card	1 per card
Max address per loop	200	200	200	200	200	200	200
Max addresses per panel	400	200	400	800	800	400	800
Max current per loop	220mA	220mA	220mA	220mA	220mA	600mA	600mA
Max network size	N/A	126 panels	126 panels	126 panels	126 panels	250 panels	250 panels
Conventional circuits	4	2	2	4	4	2 per Sounder card	2 per Sounder card
Screen type	LCD	Touchscreen	Touchscreen	Touchscreen	Touchscreen	7" Colour touchscreen	7" Colour touchscreen
Interface	Deep menus with physical buttons	Deep menus with touchscreen	Deep menus with touchscreen	Deep menus with touchscreen	Deep menus with touchscreen	Instantly familiar - icons, large clear buttons, colour-coded	Instantly familiar - icons, large clear buttons, colour-coded
Cybersecure	N/A	N/A	N/A	N/A	N/A	Yes	Yes
Certification	EN54-2 EN54-4	EN54-2 EN54-4	EN54-2 EN54-4	EN54-2 EN54-4	EN54-2 EN54-4	EN54-2 EN54-4	EN54-2 EN54-4
Quality mark	LPCB	VdS	VdS	VdS	N/A	LPCB	LPCB

Example complete system

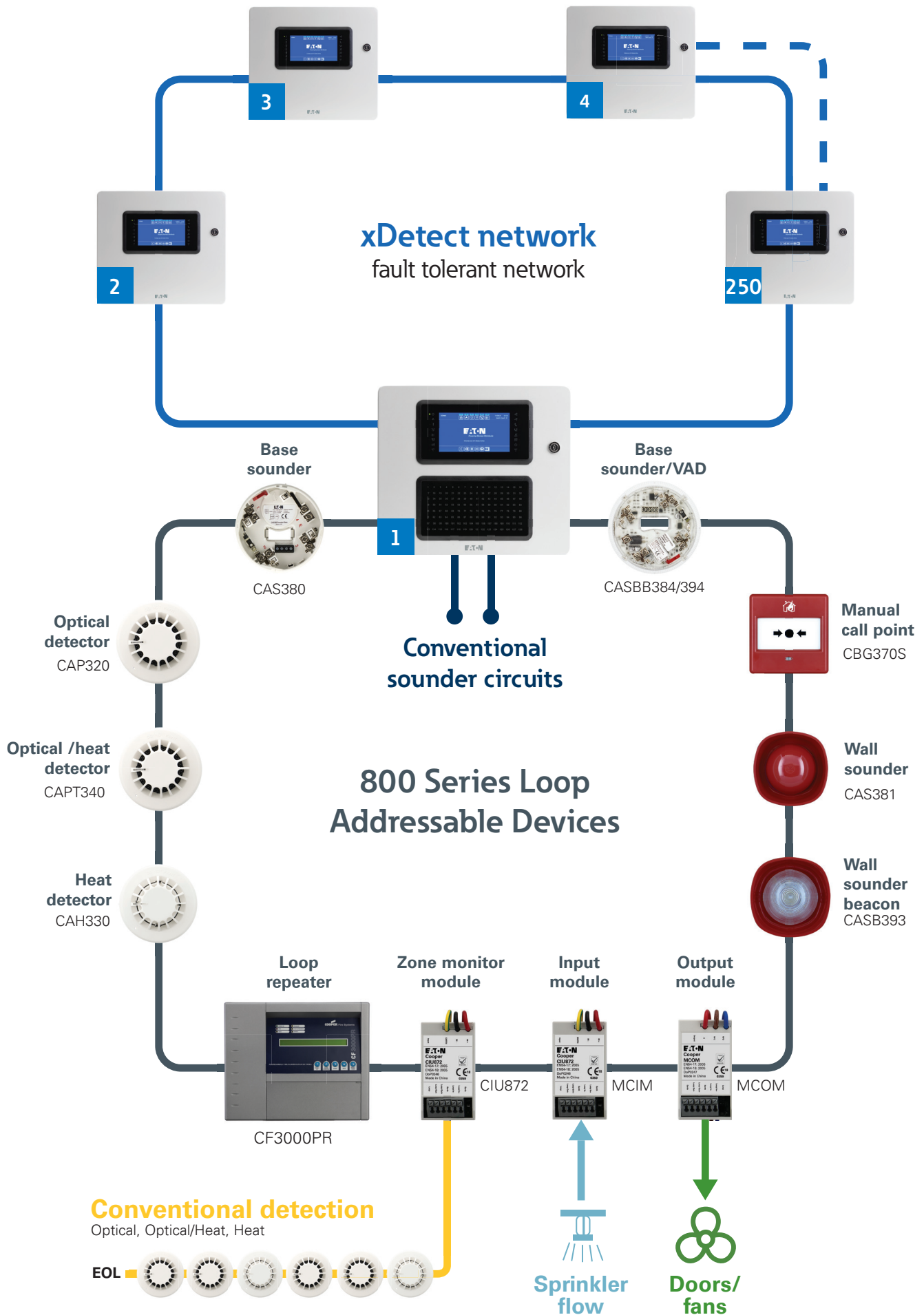



We make “safe and sound” work.*

- * At Eaton, we’re continually implementing safer processes to protect employees (yours and ours), educating our customers and partners on best practices and engineering solutions to create a safer world for everyone. Because when it comes to safety, there’s no taking time off.

[See more at Eaton.com/WhatMatters](https://www.eaton.com/WhatMatters)

Eaton
Electrical Sector EMEA
Route de la Longeraie 7
1110 Morges, Switzerland

Eaton Electrical Products Ltd
Llantarnam Park
Cwmbran, NP44 3AW
United Kingdom
www.eaton.com

© 2021 - 2024 Eaton
All rights reserved
Publication No. BR450043EN
January 2024

Information is believed to be accurate, however no representation or warranty is given and Eaton assumes no liability with respect to the accuracy of such information. The information provided in this document is subject to change without notice.

Eaton is a registered trademark.

All other trademarks are property of their respective owners

Follow us on social media to get the latest product and support information.

